

# CORREAS

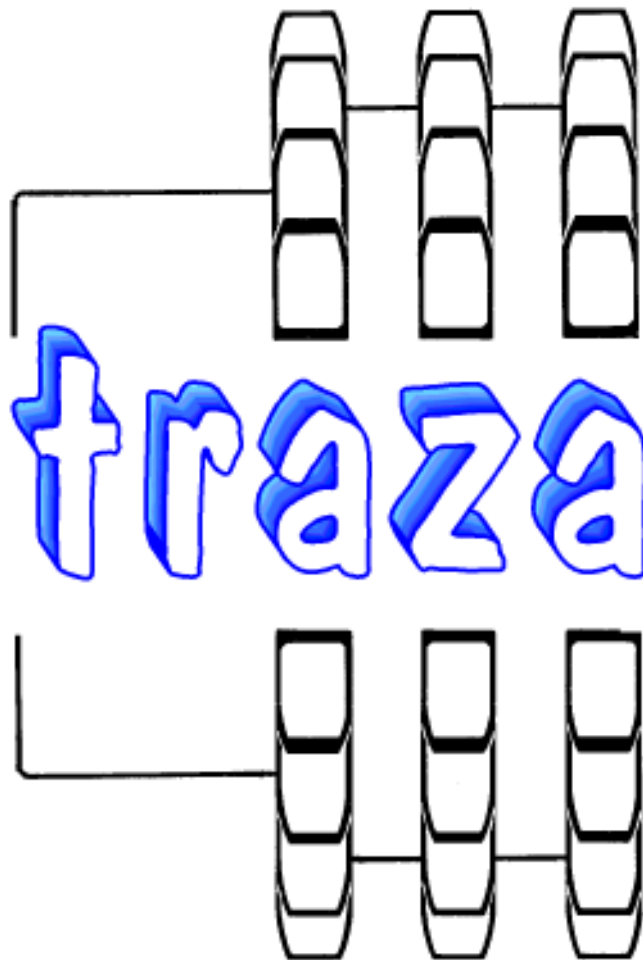

Transmisiones Zaragoza, S.L.

Isla de Menorca, s/nr. - Edificio Estrella, Local nr. 2  
50014 - Zaragoza

Tfno. (976) 47 01 02 (8 líneas) - Fax (976) 47 32 20

E-Mail: [traza@trazasl.com](mailto:traza@trazasl.com)

[www.trazasl.com](http://www.trazasl.com)

# Transmisiones Zaragoza, S.L.

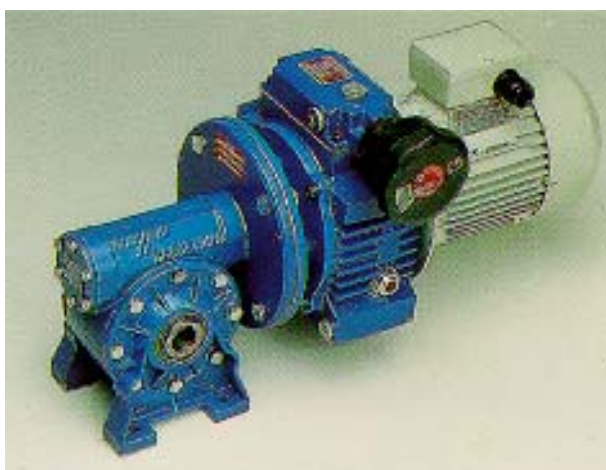

# Indice

## C

### CORREAS

#### DENTADAS

- Abierta, 44
- Clásicas, 28
- Paso M, 40
- Paso métrico AT, 38
- Paso métrico T, 34
- Paso R, 38

#### PLANAS

- Alta velocidad, 28

#### POLY-V

- Poly-V, 44

#### TERMOSOLDABLES

- Termosoldables, 26

#### TRAPECIALES

- Abiertas, 22
- Exagonales, 20
- Perfil clásico, 5
- Perfil clásico línea X, 12
- Perfil estrecho, 8
- Perfil estrecho línea X, 14
- Perfil M, 22
- Perfil V, 18
- Perfil VX, 18

#### VARIADOR

- Variador velocidad, 24



# CORREAS TRAPECIALES PERFIL CLASICO

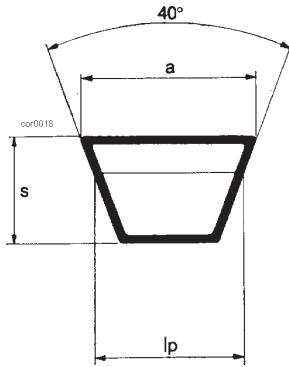

Fig. 1

a = ancho de la base mayor.  
s = espesor de la correa.  
lp = ancho primitivo.

Sección cor0019	a mm	s mm	lp mm
Z	10	6	8,5
A	13	8	11
B	17	11	14
C	22	14	19
D	32	19	27
E	40	25	32



cor020	Z	A	B	C	D	E
x'	13	17	26	26	43	52
x''	25	33	43	62	76	105

**Leyenda:**

x' = Diferencia entre el desarrollo externo y el desarrollo primitivo.  
x'' = Diferencia entre el desarrollo primitivo y el desarrollo interno.

PERFIL Z		
REF.	Long. Int. Li mm.	Long. Prim. Lw mm.
Z-12	305	327
Z-14	356	378
Z-15	381	403
Z-15.7	399	421
Z-16.7	425	447
Z-17.7	450	472
Z-18.5	470	492
Z-19	483	505
Z-19.5	495	517
Z-20	508	530
Z-20.5	521	543
Z-21	530	552
Z-21.7	551	573
Z-22.2	564	586
Z-23	584	606
Z-24	610	632
Z-24.7	630	652
Z-25.7	653	675
Z-27	686	708
Z-28	710	732
Z-29.5	749	771
Z-30	762	784
Z-30.5	775	797
Z-30.7	780	802
Z-31.5	800	822
Z-32	780	802
Z-33	838	860
Z-33.7	856	878
Z-35	889	911
Z-35.5	902	924
Z-36	914	936
Z-36.5	927	949
Z-37	940	962
Z-37.5	953	975
Z-38	965	987

PERFIL Z		
REF.	Long. Int. Li mm.	Long. Prim. Lw mm.
Z-39	990	1012
Z-39.5	1003	1025
Z-39.7	1008	1030
Z-40.5	1029	1051
Z-41	1041	1063
Z-42	1067	1089
Z-43	1090	1112
Z-44	1120	1142
Z-45	1143	1165
Z-45.5	1156	1178
Z-46.5	1180	1202
Z-47.5	1207	1229
Z-49	1245	1267
Z-50	1270	1292
Z-50.7	1288	1310
Z-52	1320	1342
Z-53	1246	1368
Z-53.5	1360	1382
Z-54	1372	1394
Z-55	1400	1422
Z-55.7	1415	1437
Z-56.7	1440	1462
Z-58	1475	1497
Z-59	1500	1522
Z-61	1550	1572
Z-62	1575	1597
Z-63	1600	1622
Z-64	1625	1647
Z-64.7	1643	1665
Z-66	1675	1697
Z-67	1700	1722
Z-68	1725	1747
Z-69	1750	1772
Z-70	1778	1797
Z-71	1800	1822

PERFIL Z		
REF.	Long. Int. Li mm.	Long. Prim. Lw mm.
Z-73	1854	1876
Z-75	1900	1922
Z-78	1981	2003
Z-79	2007	2029
Z-82	2083	2105
Z-83	2108	2130
Z-85	2159	2182
Z-87	2210	2232
Z-88	2235	2257
Z-90	2286	2308
Z-91	2311	2333

PERFIL A		
REF.	Long. Int. Li mm.	Long. Prim. Lw mm.
A-16	407	437
A-18	457	487
A-19	480	510
A-20	508	538
A-21	535	565
A-22	560	590
A-23	584	614
A-23.5	597	627
A-24	610	640
A-25	635	665
A-26	660	690
A-27	686	716
A-28	710	740

PERFIL A		
REF.	Long. Int. Li mm.	Long. Prim. Lw mm.
A-29	737	767
A-30	762	792
A-31	787	817
A-32	813	843
A-32.5	825	855
A-33	833	868
A-34	864	894
A-35	889	919
A-36	914	944
A-37	940	970
A-37.5	953	983
A-38	965	995
A-39	990	1020
A-40	1016	1046
A-41	1041	1071
A-42	1067	1097
A-43	1090	1120
A-44	1120	1150
A-45	1143	1173
A-46	1168	1198
A-47	1194	1224
A-48	1220	1250
A-49	1245	1275
A-50	1270	1300
A-51	1295	1325
A-52	1320	1350
A-53	1350	1380
A-54	1372	1402
A-55	1400	1430
A-56	1422	1452
A-57	1450	1480
A-58	1473	1503
A-59	1500	1530
A-60	1525	1555
A-61	1550	1580
A-62	1575	1605
A-63	1600	1630
A-64	1625	1655
A-65	1650	1680
A-66	1676	1706
A-67	1700	1730
A-68	1725	1755
A-69	1750	1780
A-70	1775	1805
A-71	1800	1830
A-72	1829	1859
A-73	1854	1884
A-74	1880	1910
A-75	1900	1930
A-76	1930	1960
A-77	1956	1986
A-78	1980	2010
A-79	2007	2037
A-80	2032	2062
A-81	2060	2090
A-82	2083	2113
A-83	2110	2140
A-84	2134	2164
A-85	2160	2190
A-86	2184	2214
A-87	2210	2240
A-88	2235	2265

PERFIL A		
REF.	Long. Int. Li mm.	Long. Prim. Lw mm.
A-89	2261	2291
A-90	2286	2316
A-91	2310	2340
A-92	2337	2367
A-93	2360	2390
A-94	2388	2418
A-95	2413	2443
A-96	2438	2468
A-97	2464	2494
A-98	2489	2519
A-99	2515	2545
A-100	2540	2570
A-102	2591	2621
A-103	2616	2646
A-104	2642	2672
A-105	2667	2697
A-106	2692	2722
A-107	2718	2748
A-108	2743	2773
A-109	2769	2799
A-110	2794	2824
A-111	2820	2850
A-112	2845	2875
A-113	2870	2900
A-114	2900	2930
A-116	2950	2980
A-118	3000	3030
A-119	3024	3054
A-120	3048	3078
A-124	3150	3180
A-127	3225	3255
A-128	3250	3280
A-130	3302	3332
A-132	3350	3380
A-134	3404	3434
A-136	3454	3484
A-138	3505	3535
A-140	3550	3580
A-143	3632	3662
A-144	3658	3688
A-148	3759	3789
A-158	4013	4043
A-162	4115	4145
A-167	4242	4272
A-173	4394	4424
A-175	4445	4475
A-180	4572	4602
A-187	4570	4600
A-196	4978	5008
A-210	5334	5364
A-217	5512	5542

PERFIL B		
REF.	Long. Int. Li mm.	Long. Prim. Lw mm.
B-23	584	627
B-26	660	703
B-27	686	729
B-28	710	753
B-29	737	780
B-30	762	805
B-31	787	830
B-32	813	856
B-33	838	881
B-34	864	907
B-35	889	932
B-36	914	957
B-37	940	983
B-37.5	953	996
B-38	965	1008
B-39	990	1033
B-40	1016	1059
B-41	1041	1084
B-42	1067	1110
B-43	1090	1033
B-44	1120	1163
B-45	1143	1186
B-46	1168	1211
B-47	1194	1237
B-48	1219	1262
B-49	1245	1288
B-50	1270	1313
B-51	1295	1338
B-52	1320	1363
B-53	1350	1393
B-54	1372	1415
B-55	1400	1443
B-56	1422	1465
B-57	1450	1493
B-58	1473	1516
B-59	1500	1543
B-60	1525	1568
B-61	1550	1593
B-62	1575	1618
B-63	1600	1643
B-64	1625	1668
B-65	1650	1693
B-66	1676	1719
B-67	1700	1743
B-68	1725	1768
B-69	1750	1793
B-70	1775	1818
B-71	1800	1843
B-72	1829	1872
B-73	1854	1897
B-74	1880	1923
B-75	1900	1943
B-76	1930	1973
B-77	1956	1999
B-78	1981	2024
B-79	2007	2050
B-80	2032	2075
B-81	2060	2103
B-82	2083	2126
B-83	2108	2151
B-84	2134	2177
B-85	2160	2203

PERFIL B		
REF.	Long. Int. Li mm.	Long. Prim. Lw mm.
B-86	2184	2227
B-87	2210	2253
B-88	2235	2278
B-89	2261	2304
B-90	2286	2329
B-91	2311	2354
B-92	2337	2380
B-93	2360	2403
B-94	2388	2431
B-95	2413	2456
B-96	2438	2481
B-97	2464	2507
B-98	2489	2532
B-99	2515	2558
B-100	2540	2583
B-101	2565	2608
B-102	2591	2634
B-103	2616	2659
B-104	2642	2685
B-105	2667	2710
B-106	2692	2735
B-107	2718	2761
B-108	2743	2786
B-109	2769	2812
B-110	2794	2837
B-112	2845	2888
B-113	2870	2913
B-114	2900	2943
B-115	2921	2964
B-116	2950	2993
B-117	2972	3015
B-118	3000	3043
B-120	3048	3091
B-122	3099	3142
B-124	3150	3193
B-125	3175	3218
B-126	3200	3243
B-127	3226	3269
B-128	3250	3293
B-130	3302	3345
B-132	3350	3393
B-133	3378	3421
B-134	3404	3447
B-135	3429	3472
B-136	3450	3493
B-138	3505	3548
B-140	3550	3593
B-142	3607	3650
B-143	3632	3675
B-144	3658	3701
B-146	3708	3751
B-148	3759	3802
B-150	3810	3853
B-151	3835	3878
B-152	3861	3904
B-153	3886	3929
B-154	3912	3955
B-155	3937	3980
B-156	3962	4005
B-157	3988	4031
B-158	4013	4056
B-160	4064	4107

PERFIL B		
REF.	Long. Int. Li mm.	Long. Prim. Lw mm.
B-162	4115	4158
B-163	4140	4183
B-165	4191	4234
B-167	4242	4285
B-168	4267	4310
B-170	4318	4361
B-172	4369	4412
B-173	4394	4437
B-175	4445	4488
B-177	4500	4543
B-180	4572	4615
B-185	4699	4742
B-187	4750	4793
B-188	4775	4818
B-189	4800	4843
B-191	4851	4894
B-192	4877	4920
B-193	4900	4943
B-195	4953	4996
B-197	5000	5043
B-204	5182	5225
B-208	5283	5326
B-210	5334	5377
B-216	5486	5529
B-220	5588	5631
B-223	5664	5707
B-224	5689	5732
B-225	5715	5758
B-228	5791	5834
B-236	5995	6038
B-240	6096	6139
B-248	6300	6343
B-270	6858	6901
B-275	6985	7028
B-276	7010	7053
B-300	7620	7663
B-330	8382	8425
B-345	8763	8806

PERFIL C		
REF.	Long. Int. Li mm.	Long. Prim. Lw mm.
C-37	940	1005
C-38	965	1030
C-39.7	1008	1073
C-40	1016	1081
C-41	1041	1106
C-42	1067	1132
C-43	1090	1155
C-44	1120	1185
C-45	1143	1208
C-46	1168	1233
C-47	1194	1259
C-48	1219	1284
C-49	1245	1310
C-50	1270	1335
C-51	1295	1360
C-52	1320	1385
C-53	1350	1415
C-54	1372	1437
C-55	1400	1465
C-56	1422	1487
C-57	1450	1515
C-58	1473	1538
C-59	1500	1565
C-60	1524	1589
C-61	1550	1615
C-62	1575	1640
C-63	1600	1665
C-64	1625	1690
C-65	1650	1715
C-66	1676	1741
C-67	1700	1765
C-68	1727	1792
C-69	1750	1815
C-70	1775	1840
C-71	1800	1865
C-72	1829	1894
C-73	1854	1919
C-74	1880	1945
C-75	1900	1965
C-76	1930	1995
C-77	1956	2021
C-78	1981	2046
C-79	2007	2072
C-80	2032	2097
C-81	2060	2125
C-82	2083	2148
C-83	2108	2173
C-84	2134	2199
C-85	2160	2225
C-86	2184	2249
C-87	2210	2275
C-88	2235	2300
C-89	2261	2326
C-90	2286	2351
C-91	2311	2376
C-92	2337	2402
C-93	2360	2425
C-94	2388	2453



PERFIL C		
REF.	Long. Int. Li mm.	Long. Prim. Lw mm.
C-95	2413	2478
C-96	2438	2503
C-97	2464	2529
C-98	2489	2554
C-99	2515	2580
C-100	2540	2605
C-101	2565	2630
C-102	2591	2656
C-103	2616	2681
C-104	2642	2707
C-105	2667	2732
C-106	2692	2757
C-107	2718	2783
C-108	2743	2808
C-109	2769	2834
C-110	2794	2859
C-111	2819	2884
C-112	2845	2910
C-113	2870	2935
C-114	2900	2965
C-115	2921	2986
C-116	2950	3015
C-117	2972	3037
C-118	3000	3065
C-119	3033	3098
C-120	3048	3113
C-121	3073	3138
C-122	3099	3164
C-124	3150	3215
C-125	3175	3240
C-126	3200	3265
C-127	3226	3291
C-128	3250	3315
C-130	3302	3367
C-131	3327	3392
C-132	3350	3415
C-133	3378	3443
C-134	3404	3469
C-136	3450	3515
C-137	3480	3545
C-139	3531	3596
C-140	3550	3615
C-142	3607	3672
C-144	3658	3723
C-145	3683	3748
C-146	3708	3773
C-148	3759	3824
C-150	3810	3875
C-151	3835	3900
C-152	3861	3926
C-154	3912	3977
C-155	3937	4002
C-156	3962	4027
C-157	3988	4053
C-158	4013	4078
C-159	4038	4103
C-160	4064	4129
C-162	4115	4180
C-164	4166	4231
C-166	4216	4281
C-167	4241	4306

PERFIL C		
REF.	Long. Int. Li mm.	Long. Prim. Lw mm.
C-168	4267	4332
C-170	4318	4383
C-172	4369	4434
C-173	4394	4459
C-175	4445	4510
C-177	4496	4561
C-180	4572	4637
C-184	4673	4738
C-186	4724	4789
C-187	4750	4815
C-193	4900	4965
C-194	4925	4990
C-195	4953	5018
C-197	5000	5065
C-198	5025	5090
C-202	5127	5192
C-204	5182	5247
C-210	5334	5399
C-211	5360	5425
C-220	5588	5653
C-224	5690	5755
C-225	5715	5780
C-228	5791	5856
C-236	5994	6059
C-238	6045	6110
C-240	6096	6161
C-248	6300	6365
C-255	6477	6542
C-270	6858	6923
C-276	7010	7075
C-285	7239	7304
C-300	7620	7685
C-315	8001	8066
C-330	8382	8447
C-336	8534	8600
C-360	9144	9209
C-394	10008	10073
C-420	10668	10733

PERFIL D		
REF.	Long. Int. Li mm.	Long. Prim. Lw mm.
D-89	2261	2330
D-94	2388	2457
D-98	2489	2558
D-105	2667	2736
D-110	2800	2869
D-120	3048	3117
D-121	3073	3142
D-123	3124	3193
D-125	3175	3244
D-128	3251	3320
D-133	3378	3447
D-134	3404	3473
D-135	3429	3498
D-136	3454	3523
D-140	3550	3619
D-143	3632	3701
D-144	3658	3727
D-148	3759	3828
D-152	3861	3930
D-154	3912	3981
D-156	3962	4031
D-157	3988	4057
D-158	4013	4082
D-159	4039	4108
D-160	4064	4133
D-162	4115	4184
D-163	4140	4209
D-167	4242	4311
D-169	4293	4362
D-173	4394	4463
D-175	4445	4514
D-177	4496	4565
D-180	4572	4641
D-195	4953	5022
D-197	5004	5073
D-210	5334	5403
D-220	5588	5657
D-225	5715	5784
D-240	6096	6165
D-248	6300	6369
D-250	6350	6419
D-255	6477	6546
D-270	6858	6927
D-300	7620	7689
D-315	8001	8070
D-330	8382	8451
D-360	9144	9213
D-390	9906	9975
D-441	11201	11270
D-600	15240	15309



## CORREAS TRAPECIALES DE PERFIL ESTRECHO

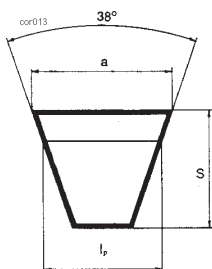

Sección cor012	a mm	s mm	lp mm
SPZ	9,7	8	8,5
SPA	12,7	10	11
SPB	16,3	13	14
SPC	22	18	19



a = ancho nominal de la base mayor.  
s = espesor nominal.  
lp = ancho primitivo.

PERFIL SPZ		
Long. Prim. Lw mm.	UNIF. USA	Long. Ext. La mm.
SPZ-562		575
SPZ-587		600
SPZ-612		625
SPZ-630	3V-250	643
SPZ-637		650
SPZ-662		675
SPZ-670	3V-265	683
SPZ-687		700
SPZ-710	3V-280	723
SPZ-737		750
SPZ-750	3V-300	763
SPZ-762		775
SPZ-772		785
SPZ-780		793
SPZ-787		800
SPZ-800	3V-315	813
SPZ-812		825
SPZ-825		838
SPZ-837		850
SPZ-850	3V-335	863
SPZ-862		875
SPZ-875		888
SPZ-887		900
SPZ-900	3V-355	913
SPZ-912		925
SPZ-925		938
SPZ-937		950
SPZ-950	3V-375	983
SPZ-962		975
SPZ-987		1000
SPZ-1000		1013
SPZ-1012	3V-400	1025
SPZ-1024		1037
SPZ-1037		1050
SPZ-1047		1060
SPZ-1060		1073
SPZ-1077	3V-425	1090

PERFIL SPZ		
Long. Prim. Lw mm.	UNIF. USA	Long. Ext. La mm.
SPZ-1087		1100
SPZ-1112		1125
SPZ-1120		1133
SPZ-1137	3V-450	1150
SPZ-1150		1160
SPZ-1162		1175
SPZ-1180		1193
SPZ-1187		1200
SPZ-1202	3V-475	1215
SPZ-1212		1225
SPZ-1237		1250
SPZ-1250		1263
SPZ-1262	3V-500	1275
SPZ-1270		1283
SPZ-1287		1300
SPZ-1312		1325
SPZ-1320		1333
SPZ-1337	3V-530	1350
SPZ-1347		1360
SPZ-1362		1375
SPZ-1387		1400
SPZ-1400		1413
SPZ-1412	3V-560	1425
SPZ-1437		1450
SPZ-1462		1475
SPZ-1487		1500
SPZ-1500		1513
SPZ-1512	3V-600	1525
SPZ-1537		1550
SPZ-1562		1575
SPZ-1587		1600
SPZ-1600	3V-630	1613
SPZ-1612		1625
SPZ-1625		1638
SPZ-1637		1650
SPZ-1662		1675
SPZ-1687		1700

PERFIL SPZ		
Long. Prim. Lw mm.	UNIF. USA	Long. Ext. La mm.
SPZ-1700	3V-670	1713
SPZ-1737		1750
SPZ-1762		1775
SPZ-1787		1800
SPZ-1800	3V-710	1813
SPZ-1812		1825
SPZ-1837		1850
SPZ-1850		1863
SPZ-1862		1875
SPZ-1887		1900
SPZ-1900	3V-750	1913
SPZ-1937		1950
SPZ-1987		2000
SPZ-2000		2013
SPZ-2037	3V-800	2050
SPZ-2087		2100
SPZ-2120		2133
SPZ-2137		2150
SPZ-2160	3V-850	2173
SPZ-2187		2200
SPZ-2240		2253
SPZ-2287	3V-900	2300
SPZ-2360		2373
SPZ-2410	3V-950	2423
SPZ-2500		2513
SPZ-2540	3V-1000	2553
SPZ-2650		2663
SPZ-2690	3V-1060	2703
SPZ-2800		2813
SPZ-2840	3V-1120	2853
SPZ-3000	3V-1180	3013
SPZ-3150		3163
SPZ-3170	3V-1250	3183
SPZ-3350	3V-1320	3363
SPZ-3550	3V-1400	3563



PERFIL SPB		
Long. Prim. Lw mm.	UNIF. USA	Long. Ext. La mm.
SPB-1250	5V-500	1272
SPB-1320	5V-530	1342
SPB-1400	5V-560	1422
SPB-1440		1462
SPB-1500	5V-600	1522
SPB-1600	5V-630	1622
SPB-1700	5V-670	1722
SPB-1750		1772
SPB-1800	5V-710	1822
SPB-1850		1872
SPB-1900	5V-750	1922
SPB-1950		1972
SPB-2000	5V-800	2022
SPB-2020		2042
SPB-2030		2052
SPB-2060		2082
SPB-2120		2142
SPB-2150	5V-850	2172
SPB-2180		2202
SPB-2240		2262
SPB-2285	5V-900	2307
SPB-2330		2352
SPB-2360		2382
SPB-2410		2432
SPB-2430		2452
SPB-2500		2522
SPB-2530	5V-1000	2552
SPB-2575		2597
SPB-2650	5V-1060	2672
SPB-2730		2752
SPB-2760		2782
SPB-2800		2822
SPB-2840	5V-1120	2862
SPB-2900		2922
SPB-3000	5V-1180	3022
SPB-3070		3092
SPB-3150	5V-1250	3172
SPB-3250		3272
SPB-3350	5V-1320	3372
SPB-3425		3447
SPB-3450		3472
SPB-3550	5V-1400	3572
SPB-3650		3672
SPB-3675		3697
SPB-3750		3772
SPB-3800	5V-1500	3822
SPB-4000		4022
SPB-4060	5V-1600	4082
SPB-4250		4272
SPB-4310	5V-1700	4332
SPB-4370		4392
SPB-4500		4522
SPB-4560	5V-1800	4582
SPB-4620		4642
SPB-4750		4772
SPB-4820	5V-1900	4842
SPB-5000		5022
SPB-5070	5V-2000	5092
SPB-5300		5322
SPB-5385	5V-2120	5407
SPB-5600		5622
SPB-5680	5V-2240	5702

PERFIL SPB		
Long. Prim. Lw mm.	UNIF. USA	Long. Ext. La mm.
SPB-6000	5V-2360	6022
SPB-6300	5V-2500	6322
SPB-6700	5V-2650	6722
SPB-7100	5V-2800	7122
SPB-7500		7522
SPB-8000	5V-3150	8022

PERFIL SPC		
Long. Prim. Lw mm	Long. Ext. La mm	
SPC-2000	2030	
SPC-2120	2150	
SPC-2240	2270	
SPC-2360	2390	
SPC-2500	2530	
SPC-2650	2680	
SPC-2800	2830	
SPC-3000	3030	
SPC-3150	3180	
SPC-3350	3380	
SPC-3500	3530	
SPC-3550	3580	
SPC-3750	3780	
SPC-4000	4030	
SPC-4100	4130	
SPC-4250	4280	
SPC-4400	4430	
SPC-4500	4530	
SPC-4750	4780	
SPC-5000	5030	
SPC-5115	5145	
SPC-5135	5165	
SPC-5300	5330	
SPC-5600	5630	
SPC-6000	6030	
SPC-6300	6330	
SPC-6600	6630	
SPC-6700	6730	
SPC-7100	7130	
SPC-7450	7480	
SPC-7500	7530	
SPC-8000	8030	
SPC-8500	8530	
SPC-9000	9030	
SPC-9500	9530	
SPC-10000	10030	
SPC-10600	10630	
SPC-11200	11230	
SPC-11800	11830	
SPC-12500	12530	

# CORREAS TRAPECIALES PERFIL CLASICO LINEA X

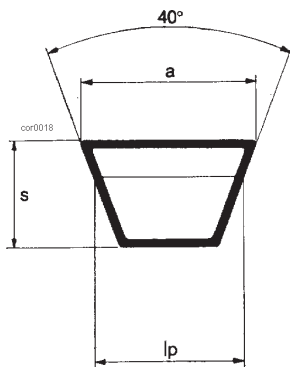

Fig. 1

a = ancho de la base mayor.  
s = espesor de la correa.  
lp = ancho primitivo.

Sección cor0019	a mm	s mm	lp mm
Z X	10	6	8,5
A X	13	8	11
B X	17	11	14
C X	22	14	19



cor0020	Z	A	B	C
x'	13	17	26	26
x''	25	33	43	62

### Leyenda:

x' = Diferencia entre el desarrollo externo y el desarrollo primitivo.  
x'' = Diferencia entre el desarrollo primitivo y el desarrollo interno.

PERFIL ZX		
REF.	Long. Int. Li mm.	Long. Prim. Lw mm.
ZX-19	483	505
ZX-19.5	495	517
ZX-20	508	530
ZX-20.5	521	543
ZX21	530	552
ZX-21.7	551	573
ZX-22.2	564	586
ZX-23	584	606
ZX-24	610	632
ZX-24.7	630	652
ZX-25.7	653	675
ZX-27	686	708
ZX-28	710	732
ZX-29.5	749	771
ZX-30	762	784
ZX-30.5	775	797
ZX-30.7	780	802
ZX-31.5	800	822
ZX-32	813	835
ZX-33	838	860
ZX-33.7	856	878
ZX-35	889	911
ZX-35.5	902	924
ZX-36	914	936
ZX-36.5	927	949
ZX-37	940	962
ZX-37.5	953	975
ZX-38	965	987
ZX-39	990	1012
ZX-39.5	1003	1025
ZX-39.7	1008	1030
ZX-40.5	1029	1051
ZX-41	1041	1063
ZX-42	1067	1089
ZX-43	1090	1112
ZX-44	1120	1142
ZX-45	1143	1165

PERFIL ZX		
REF.	Long. Int. Li mm.	Long. Prim. Lw mm.
ZX-45.5	1156	1178
ZX-46.5	1180	1202
ZX-47.5	1207	1229
ZX-49	1245	1267
ZX-50	1270	1292
ZX-50.7	1288	1310
ZX-52	1320	1342
ZX-53	1346	1368
ZX-53.5	1360	1382
ZX-54	1372	1394
ZX-55	1400	1422
ZX-55.7	1415	1437
ZX-56.7	1440	1462
ZX-58	1475	1497
ZX-59	1500	1522
ZX-59.7	1516	1538
ZX-61	1550	1572
ZX-62	1575	1597
ZX-63	1600	1622
ZX-64	1625	1647
ZX-64.7	1643	1665
ZX-66	1675	1697
ZX-67	1700	1722
ZX-68	1725	1747
ZX-69	1750	1772
ZX-70	1778	1797
ZX-71	1800	1822
ZX-73	1854	1876
ZX-75	1900	1922
ZX-78	1981	2003
ZX-79	2007	2029
ZX-82	2083	2105
ZX-85	2159	2182
ZX-88	2235	2257
ZX-90	2286	2308
ZX-91	2311	233

PERFIL AX		
REF.	Long. Int. Li mm.	Long. Prim. Lw mm.
AX-19	480	507
AX-20	508	538
AX-21	535	563
AX-22	560	588
AX-23	584	614
AX-23.5	596	626
AX-24	610	640
AX-25	635	665
AX-26	660	690
AX-27	686	716
AX-27.5	699	729
AX-28	710	741
AX-29	737	767
AX-29.5	750	780
AX-30	762	792
AX-31	787	817
AX-31.5	800	830
AX-32	813	843
AX-32.5	825	855
AX-33	838	868
AX-34	864	894
AX-34.5	875	906
AX-35	889	919
AX-36	914	944
AX-37	940	970
AX-37.5	953	983
AX-38	965	995
AX-38.5	977	1007
AX-39	990	1021
AX-40	1016	1046
AX-41	1041	1070
AX-42	1067	1097
AX-42.5	1079	1109
AX-43	1090	1122
AX-44	1120	1148
AX-44.5	1132	1160

PERFIL AX		
REF.	Long. Int. Li mm.	Long. Prim. Lw mm.
AX-45	1143	1175
AX-45.5	1155	1187
AX-46	1168	1198
AX-46.5	1180	1210
AX-47	1194	1224
AX-48	1220	1249
AX-49	1245	1275
AX-50	1270	1300
AX-51	1295	1325
AX-52	1320	1351
AX-53	1350	1376
AX-54	1372	1402
AX-55	1400	1430
AX-56	1422	1452
AX-57	1450	1480
AX-58	1473	1503
AX-59	1500	1530
AX-60	1525	1555
AX-61	1550	1580
AX-62	1575	1605
AX-63	1600	1630
AX-64	1625	1655
AX-65	1650	1680
AX-66	1676	1706
AX-67	1700	1732
AX-68	1725	1757
AX-69	1750	1780
AX-70	1775	1808
AX-71	1800	1833
AX-72	1829	1859
AX-73	1854	1884
AX-74	1880	1909
AX-75	1900	1935
AX-76	1930	1960
AX-77	1956	1986
AX-78	1980	2011
AX-79	2007	2037
AX-80	2032	2062
AX-81	2060	2090
AX-82	2083	2113
AX-83	2110	2140
AX-84	2134	2164
AX-85	2160	2189
AX-86	2184	2214
AX-87	2210	2240
AX-88	2235	2265
AX-89	2261	2291
AX-90	2286	2316
AX-91	2310	2340
AX-92	2337	2367
AX-93	2360	2390
AX-94	2388	2418
AX-95	2413	2443
AX-96	2438	2468
AX-97	2464	2494
AX-98	2489	2519
AX-99	2515	2545
AX-100	2540	2570
AX-102	2591	2621
AX-103	2616	2646
AX-104	2642	2672
AX-105	2667	2697

PERFIL AX		
REF.	Long. Int. Li mm.	Long. Prim. Lw mm.
AX-106	2692	2722
AX-107	2718	2748
AX-108	2743	2773
AX-110	2794	2824
AX-112	2845	2875
AX-113	2870	2900
AX-114	2896	2930
AX-116	2950	2980
AX-118	3000	3030
AX-120	3048	3078
AX-124	3150	3180
AX-128	3250	3281
AX-130	3302	3332
AX-132	3350	3383
AX-134	3404	3434
AX-136	3454	3484
AX-138	3504	3535
AX-140	3550	3586
AX-174	4420	4450

PERFIL BX		
REF.	Long. Int. Li mm.	Long. Prim. Lw mm.
BX-23	584	627
BX-26	660	703
BX-27	686	714
BX-28	710	754
BX-29	737	780
BX-30	762	805
BX-31	787	830
BX-32	813	856
BX-32.5	825	868
BX-33	838	881
BX-34	864	907
BX-35	889	932
B-X36	914	957
BX-37	940	985
BX-37.5	953	999
BX-38	965	1008
BX-39	990	1034
BX-40	1016	1059
BX-41	1041	1084
BX-42	1067	1110
BX-43	1090	1135
BX-44	1120	1161
BX-45	1143	1186
BX-46	1168	1211
BX-46.7	1187	1231
BX-47	1194	1237
BX-48	1219	1262
BX-49	1245	1288
BX-50	1270	1313
BX-51	1295	1338
BX-52	1320	1364
BX-53	1350	1389
BX-54	1372	1415
BX-55	1400	1440
BX-56	1422	1465
BX-57	1450	1491
BX-58	1473	1516
BX-59	1500	1542
BX-60	1525	1567
BX-61	1550	1592
BX-62	1575	1618
BX-63	1600	1643
BX-64	1625	1669
BX-65	1650	1694
BX-66	1676	1719
BX-67	1700	1745
BX-68	1725	1770
BX-69	1750	1796
BX-70	1775	1821
BX-71	1800	1846
BX-72	1829	1868
BX-73	1854	1897
BX-74	1880	1927
BX-75	1900	1948
BX-76	1930	1976
BX-77	1956	1999
BX-78	1981	2024
BX-79	2007	2050
BX-80	2032	2075
BX-81	2060	2100
BX-82	2083	2126
BX-83	2108	2151

PERFIL BX		
REF.	Long. Int. Li mm.	Long. Prim. Lw mm.
BX-84	2134	2176
BX-85	2160	2202
BX-86	2184	2227
BX-87	2210	2258
BX-88	2235	2278
BX-89	2261	2307
BX-90	2286	2329
BX-91	2311	2354
BX-92	2337	2380
BX-93	2360	2405
BX-94	2388	2431
BX-95	2413	2456
BX-96	2438	2481
BX-97	2464	2507
BX-98	2489	2532
BX-99	2515	2558
BX-100	2540	2583
BX-101	2565	2615
BX-102	2591	2634
BX-103	2616	2659
BX-104	2642	2685
BX-105	2667	2710
BX-106	2692	2735
BX-107	2718	2761
BX-108	2743	2786
BX-109	2769	2812
BX-110	2794	2837
BX-112	2845	2888
BX-113	2870	2913
BX-114	2900	2939
BX-115	2921	2964
BX-116	2950	2989
BX-117	2972	3015
BX-118	3000	3040
BX-120	3048	3091
BX-122	3099	3142
BX-124	3150	3193
BX-125	3175	3218
BX-126	3200	3243
BX-127	3226	3269
BX-128	3250	3294
BX-130	3302	3345
BX-132	3350	3396
BX-133	3378	3421
BX-134	3404	3447
BX-136	3450	3497
BX-138	3505	3548
BX-140	3550	3599

PERFIL CX		
REF.	Long. Int. Li mm.	Long. Prim. Lw mm.
CX-42	1067	1132
CX-43	1090	1155
CX-44	1120	1185
CX-45	1143	1208
CX-46	1168	1233
CX-47	1194	1259
CX-48	1219	1284
CX-49	1245	1310
CX-50	1270	1335
CX-51	1295	1360
CX-52	1320	1385
CX-53	1350	1415
CX-54	1372	1437
CX-55	1400	1465
CX-56	1422	1487
CX-57	1450	1515
CX-58	1473	1538
CX-59	1500	1565
CX-60	1524	1589
CX-61	1550	1615
CX-62	1575	1640
CX-63	1600	1665
CX-64	1625	1690
CX-65	1650	1715
CX-66	1676	1741
CX-67	1700	1765
CX-68	1727	1792
CX-69	1753	1815
CX-70	1775	1840
CX-71	1800	1865
CX-72	1829	1894
CX-73	1854	1919
CX-74	1880	1945
CX-75	1900	1965
CX-76	1930	1995
CX-77	1956	2021
CX-78	1981	2046
CX-79	2007	2072
CX-80	2032	2097
CX-81	2060	2125
CX-82	2083	2148
CX-83	2108	2173
CX-84	2134	2199
CX-85	2160	2225
CX-86	2184	2249
CX-87	2210	2275
CX-88	2235	2300
CX-89	2261	2326
CX-90	2286	2351
CX-91	2311	2376
CX-92	2337	2402
CX-93	2360	2425
CX-94	2388	2453
CX-95	2413	2478
CX-96	2438	2503
CX-97	2464	2529
CX-98	2489	2554
CX-99	2515	2580
CX-100	2540	2605
CX-101	2565	2630
CX-102	2591	2656
CX-103	2616	2681

PERFIL CX		
REF.	Long. Int. Li mm.	Long. Prim. Lw mm.
CX-104	2642	2707
CX-105	2667	2732
CX-106	2692	2757
CX-107	2718	2783
CX-108	2743	2808
CX-109	2769	2834
CX-110	2794	2859
CX-111	2819	2884
CX-112	2845	2910
CX-113	2870	2935
CX-114	2900	2965
CX-115	2921	2986
CX-116	2950	3015
CX-117	2972	3037
CX-118	3000	3065
CX-120	3048	3113
CX-122	3099	3164
CX-124	3150	3215
CX-125	3175	3240
CX-126	3200	3265
CX-127	3226	3291
CX-128	3250	3315
CX-130	3302	3367
CX-132	3350	3415
CX-133	3378	3443
CX-134	3404	3469
CX-136	3450	3515
CX-137	3480	3545
CX-140	3550	3615



## CORREAS TRAPECIALES DE PERFIL ESTRECHO LINEA X

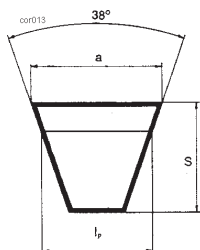

a = ancho nominal de la base mayor.  
s = espesor nominal.  
lp = ancho primitivo.



Sección cor022	a mm	s mm	lp mm
SPZX/3VX	9,7	8	8,5
SPAX	12,7	10	11
SPBX/5VX	16,3	13	14
SPCX	22	18	19

PERFIL XPZ		
Long. Prim. Lw mm.	UNIF. USA	Long. Ext. La mm.
XPZ-587		600
XPZ-612		625
XPZ-630	3VX-250	643
XPZ-637		650
XPZ-662		675
XPZ-670	3VX-265	683
XPZ-687		700
XPZ-710	3VX-280	723
XPZ-722		735
XPZ-737		750
XPZ-750	3VX-300	763
XPZ-762		775
XPZ-772		785
XPZ-780		793
XPZ-787		800
XPZ-795		808
XPZ-800	3VX-315	813
XPZ-812		825
XPZ-825		838
XPZ-837		850
XPZ-850	3VX-335	863
XPZ-862		875
XPZ-875		888
XPZ-887		900
XPZ-900	3VX-355	913
XPZ-912		925
XPZ-925		938
XPZ-930		943
XPZ-937		950
XPZ-950	3VX-375	983
XPZ-962		975
XPZ-987		1000
XPZ-1000		1013
XPZ-1012	3VX-400	1025
XPZ-1024		1037
XPZ-1037		1050

PERFIL XPZ		
Long. Prim. Lw mm.	UNIF. USA	Long. Ext. La mm.
XPZ-1047		1060
XPZ-1060		1073
XPZ-1077	3VX-425	1090
XPZ-1087		1100
XPZ-1112		1125
XPZ-1120		1133
XPZ-1137	3VX-450	1150
XPZ-1150		1160
XPZ-1162		1175
XPZ-1180		1193
XPZ-1187		1200
XPZ-1202	3VX-475	1215
XPZ-1212		1225
XPZ-1237		1250
XPZ-1250		1263
XPZ-1262	3VX-500	1275
XPZ-1287		1300
XPZ-1312		1325
XPZ-1320		1333
XPZ-1337	3VX-530	1350
XPZ-1362		1375
XPZ-1387		1400
XPZ-1400		1413
XPZ-1412	3VX-560	1425
XPZ-1420		1433
XPZ-1437		1450
XPZ-1462		1475
XPZ-1487		1500
XPZ-1500		1513
XPZ-1512	3VX-600	1525
XPZ-1520		1533
XPZ-1537		1550
XPZ-1562		1575
XPZ-1587		1600
XPZ-1600	3VX-630	1613
XPZ-1612		1625

PERFIL XPZ		
Long. Prim. Lw mm.	UNIF. USA	Long. Ext. La mm.
XPZ-1637		1650
XPZ-1662		1675
XPZ-1687		1700
XPZ-1700	3VX-670	1713
XPZ-1762		1775
XPZ-1787		1800
XPZ-1800	3VX-710	1813
XPZ-1850		1863
XPZ-1900	3VX-750	1913
XPZ-1987		2000
XPZ-2000		2013
XPZ-2037	3VX-800	2050
XPZ-2120		2133
XPZ-2137		2150
XPZ-2187		2200
XPZ-2240		2253
XPZ-2287	3VX-900	2300
XPZ-2360		2373
XPZ-2410	3VX-950	2423
XPZ-2500		2513
XPZ-2540	3VX-1000	2553
XPZ-2650		2663
XPZ-2685		2698
XPZ-2800		2813
XPZ-3000	3VX-1180	3013
XPZ-3150		3163
XPZ-3350	3VX-1320	3363
XPZ-3550	3VX-1400	3563

PERFIL XPA		
Long. Prim. Lw mm	Long. Ext. La mm	
XPA-732	750	
XPA-757	773	
XPA-782	800	
XPA-800	818	
XPA-807	825	
XPA-832	850	
XPA-850	868	
XPA-857	875	
XPA-882	900	
XPA-900	918	
XPA-907	925	
XPA-932	950	
XPA-950	968	
XPA-957	975	
XPA-982	1000	
XPA-1000	1018	
XPA-1007	1025	
XPA-1032	1050	
XPA-1060	1078	
XPA-1082	1100	
XPA-1107	1125	
XPA-1120	1138	
XPA-1132	1150	
XPA-1150	1168	
XPA-1157	1175	
XPA-1180	1198	
XPA-1207	1225	
XPA-1232	1250	
XPA-1250	1268	
XPA-1257	1275	
XPA-1272	1290	
XPA-1282	1300	
XPA-1307	1325	
XPA-1320	1338	
XPA-1332	1350	
XPA-1357	1375	
XPA-1382	1400	
XPA-1400	1418	
XPA-1432	1450	
XPA-1457	1475	
XPA-1482	1500	
XPA-1500	1518	
XPA-1507	1525	
XPA-1532	1550	
XPA-1550	1568	
XPA-1557	1585	
XPA-1582	1600	
XPA-1600	1616	
XPA-1607	1625	
XPA-1632	1650	
XPA-1650	1668	
XPA-1657	1675	
XPA-1700	1718	
XPA-1732	1750	
XPA-1750	1768	
XPA-1757	1775	
XPA-1782	1800	
XPA-1800	1818	
XPA-1832	1850	
XPA-1850	1868	
XPA-1900	1918	
XPA-1932	1950	

PERFIL XPA		
Long. Prim. Lw mm	Long. Ext. La mm	
XPA-1950	1968	
XPA-1982	2000	
XPA-2000	2018	
XPA-2032	2050	
XPA-2057	2075	
XPA-2082	2100	
XPA-2120	2138	
XPA-2160	2178	
XPA-2182	2200	
XPA-2240	2258	
XPA-2282	2300	
XPA-2307	2325	
XPA-2332	2350	
XPA-2360	2378	
XPA-2382	2400	
XPA-2432	2450	
XPA-2482	2500	
XPA-2500	2518	
XPA-2532	2550	
XPA-2582	2600	
XPA-2607	2625	
XPA-2632	2650	
XPA-2650	2668	
XPA-2682	2700	
XPA-2732	2750	
XPA-2782	2800	
XPA-2800	2818	
XPA-2832	2850	
XPA-2882	2900	
XPA-2932	2950	
XPA-2982	3000	
XPA-3000	3018	
XPA-3082	3100	
XPA-3150	3168	
XPA-3182	3200	
XPA-3350	3368	
XPA-3382	3400	
XPA-3550	3568	
XPA-3650	3668	
XPA-3750	3768	
XPA-3800	3818	
XPA-3850	3868	
XPA-3900	3918	
XPA-4000	4018	
XPA-4500	4518	

PERFIL XPB		
Long. Prim. Lw mm.	UNIF. USA	Long. Ext. La mm.
XPB-1250		1272
XPB-1260	5VX-500	
XPB-1320	5VX-530	1342
XPB-1400	5VX-560	1422
XPB-1430		1452
XPB-1500	5VX-600	1522
XPB-1550		1572
XPB-1600	5VX-630	1622
XPB-1700	5VX-670	1722
XPB-1800	5VX-710	1822
XPB-1850		1872
XPB-1900	5VX-750	1922
XPB-1950		1972
XPB-2000	5VX-800	2022
XPB-2020		2042
XPB-2120		2142
XPB-2150	5VX-850	2172
XPB-2180		2202
XPB-2240		2262
XPB-2270		2292
XPB-2285	5VX-900	2307
XPB-2300		2322
XPB-2360		2382
XPB-2400		2422
XPB-2410		2432
XPB-2500		2522
XPB-2530	5VX-1000	2552
XPB-2650	5VX-1060	2672
XPB-2680		2702
XPB-2730		2752
XPB-2800		2822
XPB-2840	5VX-1120	2862
XPB-2900		2922
XPB-3000	5VX-1180	3022
XPB-3150	5VX-1250	3172
XPB-3170		3192
XPB-3250		3272
XPB-3350	5VX-1320	3372
XPB-3550	5VX-1400	3572
XPB-3750		3772
XPB-3800	5VX-1500	3822
XPB-4000		4022
XPB-4060	5VX-1600	4082
XPB-4250		4272
XPB-4310	5VX-1700	4332
XPB-4500		4522
XPB-4750		4772
XPB-5000		5022



## CORREAS TRAPECIALES PERFIL V (J)

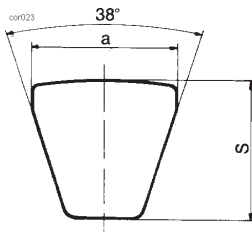

a = ancho nominal de la base mayor.  
s = espesor nominal.



Sección cor024	a mm	S mm
3V (9N)*	9	8
5V (15N)*	15	13
8V (25N)*	25	23

\* Designación estandar de la sección, según la norma RMA, relativa al sistema internacional "SI".

PERFIL 3V		
Long. Prim. Lw mm.	Long. Ext. La mm.	
3V-250	635	
3V-265	675	
3V-280	710	
3V-300	760	
3V-315	800	
3V-335	850	
3V-355	900	
3V-375	955	
3V-400	1015	
3V-425	1080	
3V-450	1145	
3V-475	1205	
3V-500	1270	
3V-530	1345	
3V-560	1420	
3V-600	1524	
3V-630	1600	
3V-670	1702	
3V-710	1803	
3V-750	1905	
3V-800	2032	
3V-850	2159	
3V-900	2286	
3V-950	2413	
3V-1000	2540	
3V-1060	2692	
3V-1120	2845	
3V-1180	2997	
3V-1250	3175	
3V-1320	3353	
3V-1400	3556	
3V-1500	3810	
3V-1600	4064	
3V-1700	4318	
3V-1800	4572	

PERFIL 5V		
Long. Prim. Lw mm.	Long. Ext. La mm.	
5V-500	1250	
5V-530	1320	
5V-560	1400	
5V-600	1500	
5V-630	1600	
5V-670	1700	
5V-710	1800	
5V-750	1900	
5V-800	2000	
5V-850	2150	
5V-900	3241	
5V-950	2413	
5V-1000	2540	
5V-1060	2692	
5V-1120	2845	
5V-1180	2997	
5V-1250	3175	
5V-1320	3353	
5V-1400	3556	
5V-1500	3810	
5V-1600	4064	
5V-1700	4318	
5V-1800	4572	
5V-1900	4826	
5V-2000	5080	
5V-2120	5385	
5V-2240	5690	
5V-2360	5994	
5V-2500	6350	
5V-2650	6731	
5V-2800	7112	
5V-3000	7620	

PERFIL 8V		
Long. Prim. Lw mm.	Long. Ext. La mm.	
8V-1000	2540	
8V-1060	2690	
8V-1120	2845	
8V-1180	2995	
8V-1250	3175	
8V-1320	3355	
8V-1400	3555	
8V-1500	3810	
8V-1600	4065	
8V-1700	4320	
8V-1800	4572	
8V-1900	4826	
8V-2000	5080	
8V-2120	5385	
8V-2240	5690	
8V-2360	5994	
8V-2500	6350	
8V-2650	6731	
8V-2800	7112	
8V-3000	4620	
8V-3150	8001	
8V-3350	8509	
8V-3550	9017	
8V-3750	9525	
8V-4000	10116	
8V-4250	10795	
8V-4500	11430	
8V-4750	12065	
8V-5000	12700	
8V-5600	14224	
8V-6000	15240	
8V-6300	16002	

# CORREAS TRAPECIALES PERFIL V X (J)

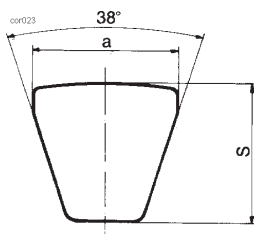

a = ancho nominal de la base mayor.  
s = espesor nominal.

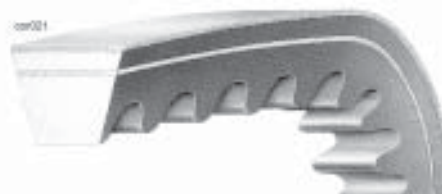

Sección cor024	a mm	S mm
3VX (9N)*	9	8
5VX (15N)*	15	13
8VX (25N)*	25	23

\* Designación estandar de la sección, según la norma RMA, relativa al sistema internacional "SI".

PERFIL 3VX		
Long. Prim. Lw mm.	Long. Ext. La mm.	
3VX-250	635	
3VX-265	675	
3VX-280	710	
3VX-300	760	
3VX-315	800	
3VX-335	850	
3VX-355	900	
3VX-375	955	
3VX-400	1015	
3VX-425	1080	
3VX-450	1145	
3VX-475	1205	
3VX-500	1270	
3VX-530	1345	
3VX-560	1420	
3VX-600	1524	
3VX-630	1600	
3VX-670	1702	
3VX-710	1803	
3VX-750	1905	
3VX-800	2032	
3VX-850	2159	
3VX-900	2286	
3VX-950	2413	
3VX-1000	2540	
3VX-1060	2692	
3VX-1120	2845	
3VX-1180	2997	
3VX-1250	3175	
3VX-1320	3353	
3VX-1400	3556	
3VX-1500	3810	
3VX-1600	4064	
3VX-1700	4318	
3VX-1800	4572	

PERFIL 5VX		
Long. Prim. Lw mm.	Long. Ext. La mm.	
5VX-500	1250	
5VX-530	1320	
5VX-560	1400	
5VX-600	1500	
5VX-630	1600	
5VX-670	1700	
5VX-710	1800	
5VX-750	1900	
5VX-800	2000	
5VX-850	2150	
5VX-900	3241	
5VX-950	2413	
5VX-1000	2540	
5VX-1060	2692	
5VX-1120	2845	
5VX-1180	2997	
5VX-1250	3175	
5VX-1320	3353	
5VX-1400	3556	
5VX-1500	3810	
5VX-1600	4064	
5VX-1700	4318	
5VX-1800	4572	
5VX-1900	4826	
5VX-2000	5080	
5VX-2120	5385	
5VX-2240	5690	
5VX-2360	5994	
5VX-2500	6350	
5VX-2650	6731	
5VX-2800	7112	
5VX-3000	7620	

PERFIL 8VX		
Long. Prim. Lw mm.	Long. Ext. La mm.	
8VX-1000	2540	
8VX-1060	2690	
8VX-1120	2845	
8VX-1180	2995	
8VX-1250	3175	
8VX-1320	3355	
8VX-1400	3555	
8VX-1500	3810	
8VX-1600	4065	
8VX-1700	4320	
8VX-1800	4572	
8VX-1900	4826	
8VX-2000	5080	
8VX-2120	5385	
8VX-2240	5690	
8VX-2360	5994	
8VX-2500	6350	
8VX-2650	6731	
8VX-2800	7112	
8VX-3000	4620	
8VX-3150	8001	
8VX-3350	8509	
8VX-3550	9017	
8VX-3750	9525	
8VX-4000	10116	
8VX-4250	10795	
8VX-4500	11430	
8VX-4750	12065	
8VX-5000	12700	
8VX-5600	14224	
8VX-6000	15240	
8VX-6300	16002	

## CORREAS TRAPECIALES EXAGONALES

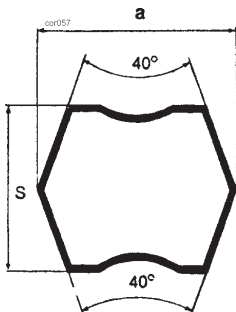

Sección	a mm	S mm
AA	12.7	10.3
BB	16.5	13.5
CC	22.2	17.5

PERFIL HAA		
REF.	Long. Ext. La mm.	
HAA-75	1956	
HAA-96	2489	
HAA-100	2591	
HAA-102	2642	
HAA-103	2667	
HAA-105	2718	
HAA-108	2794	
HAA-112	2896	
HAA-116	3001	
HAA-126	3251	
HAA-128	3301	
HAA-130	3353	
HAA-134	3455	
HAA-136	3505	
HAA-146	3759	
HAA-148	3810	
HAA-152	3912	
HAA-156	4013	
HAA-157	4039	
HAA-158	4064	
HAA-164	4217	
HAA-165	4242	
HAA-166	4267	
HAA-176	4521	
HAA-178	4572	
HAA-185	4750	
HAA-195	5004	

PERFIL HBB		
REF.	Long. Ext. La mm.	
HBB-74	1949	
HBB-75	1969	
HBB-76	1999	
HBB-78	2050	
HBB-79	2076	
HBB-80	2101	
HBB-81	2129	
HBB-83	2177	
HBB-84	2203	
HBB-85	2229	
HBB-86	2253	
HBB-88	2304	
HBB-90	2355	
HBB-91	2380	
HBB-92	2406	
HBB-94	2457	
HBB-96	2507	
HBB-97	2533	
HBB-98	2588	
HBB-100	2609	
HBB-101	2634	
HBB-105	2736	
HBB-106	2812	
HBB-107	2837	
HBB-108	2812	
HBB-110	2863	
HBB-111	2888	
HBB-112	2914	
HBB-113	2939	
HBB-115	2990	
HBB-116	3019	
HBB-118	3069	
HBB-119	3092	
HBB-120	3117	
HBB-121	3142	
HBB-123	3193	

PERFIL HBB		
REF.	Long. Ext. La mm.	
HBB-124	3218	
HBB-125	3244	
HBB-126	3269	
HBB-127	3295	
HBB-128	3319	
HBB-129	3346	
HBB-130	3371	
HBB-131	3396	
HBB-133	3447	
HBB-135	3498	
HBB-136	3519	
HBB-137	3549	
HBB-138	3574	
HBB-141	3650	
HBB-143	3701	
HBB-144	3727	
HBB-145	3752	
HBB-146	3777	
HBB-155	4006	
HBB-156	4031	
HBB-157	4057	
HBB-158	4082	
HBB-159	4108	
HBB-162	4183	
HBB-163	4209	
HBB-173	4463	
HBB-174	4489	
HBB-175	4514	
HBB-176	4539	
HBB-180	4641	
HBB-184	4743	
HBB-187	4819	
HBB-190	4895	
HBB-194	4997	
HBB-195	5022	





## CORREAS TRAPECIALES POLYMAX

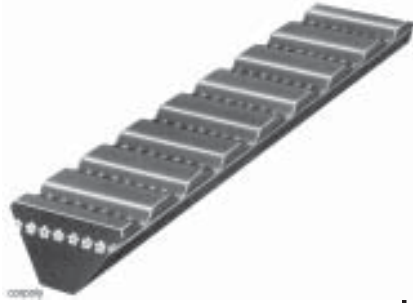

	5M	7M	11M
3	5	7	11
2	3	5	7

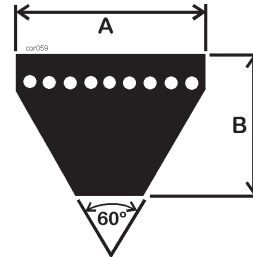

cor067

Tipo <b>3M</b>		Tipo <b>5M</b>		Tipo <b>7M</b>		Tipo <b>11M</b>	
Tipo	Desarrollo Primitivo Lw	Tipo	Desarrollo Primitivo Lw	Tipo	Desarrollo Primitivo Lw	Tipo	Desarrollo Primitivo Lw
3M180	180	5M280	280	7M500	500	11M710	710
3M185	185	5M290	290	7M515	515	11M730	730
3M190	190	5M300	300	7M530	530	11M750	750
3M195	195	5M307	307	7M545	545	11M775	775
3M200	200	5M315	315	7M560	560	11M800	800
3M206	206	5M325	325	7M580	580	11M825	825
3M212	212	5M335	335	7M600	600	11M850	850
3M218	218	5M345	345	7M615	615	11M875	875
3M224	224	5M355	355	7M630	630	11M900	900
3M230	230	5M365	365	7M650	650	11M925	925
3M236	236	5M375	375	7M670	670	11M950	950
3M243	243	5M387	387	7M690	690	11M975	975
3M250	250	5M400	400	7M710	710	11M1000	1000
3M258	258	5M412	412	7M730	730	11M1030	1030
3M265	265	5M425	425	7M750	750	11M1060	1060
3M272	272	5M437	437	7M775	775	11M1090	1090
3M280	280	5M450	450	7M800	800	11M1120	1120
3M290	290	5M462	462	7M825	825	11M1150	1150
3M300	300	5M475	475	7M850	850	11M1180	1180
3M307	307	5M487	487	7M875	875	11M1220	1220
3M315	315	5M500	500	7M900	900	11M1250	1250
3M325	325	5M515	515	7M925	925	11M1280	1280
3M335	335	5M530	530	7M950	950	11M1320	1320
3M345	345	5M545	545	7M975	975	11M1360	1360
3M355	355	5M560	560	7M1000	1000	11M1400	1400
3M365	365	5M580	580	7M1030	1030	11M1450	1450
3M375	375	5M600	600	7M1060	1060	11M1500	1500
3M387	387	5M615	615	7M1090	1090	11M1550	1550
3M400	400	5M630	630	7M1120	1120	11M1600	1600
3M412	412	5M650	650	7M1150	1150	11M1650	1650
3M425	425	5M670	670	7M1180	1180	11M1700	1700
3M437	437	5M690	690	7M1220	1220	11M1750	1750
3M450	450	5M710	710	7M1250	1250	11M1800	1800
3M462	462	5M730	730	7M1280	1280	11M1850	1850
3M475	475	5M750	750	7M1320	1320	11M1900	1900
3M487	487	5M775	775	7M1360	1360	11M1950	1950
3M500	500	5M800	800	7M1400	1400	11M2000	2000
3M515	515	5M825	825	7M1450	1450	11M2060	2060
3M530	530	5M850	850	7M1500	1500	11M2120	2120
3M545	545	5M875	875	7M1550	1550	11M2180	2180
3M560	560	5M900	900	7M1600	1600	11M2240	2240
3M580	580	5M925	925	7M1650	1650	11M2300	2300
3M600	600	5M950	950	7M1700	1700		
3M615	615	5M975	975	7M1750	1750		
3M630	630	5M1000	1000	7M1800	1800		
3M650	650	5M1030	1030	7M1850	1850		
3M670	670	5M1060	1060	7M1900	1900		
3M690	690	5M1090	1090	7M1950	1950		
3M710	710	5M1120	1120	7M2000	2000		
3M730	730	5M1150	1150	7M2060	2060		
3M750	750	5M1180	1180	7M2120	2120		
		5M1220	1220	7M2180	2180		
		5M1250	1250	7M2240	2240		
		5M1280	1280	7M2300	2300		
		5M1320	1320				
		5M1360	1360				
		5M1400	1400				
		5M1450	1450				
		5M1500	1500				

## CORREAS TRAPECIALES ABIERTAS EN METROS, PARA CERRAR CON UNION

Disponibles en los PERFILES CLASICOS: Z - A - B - C

Disponibles en los PERFILES EXAGONALES: Z - A - B

Uniones disponibles para estos mismos perfiles.

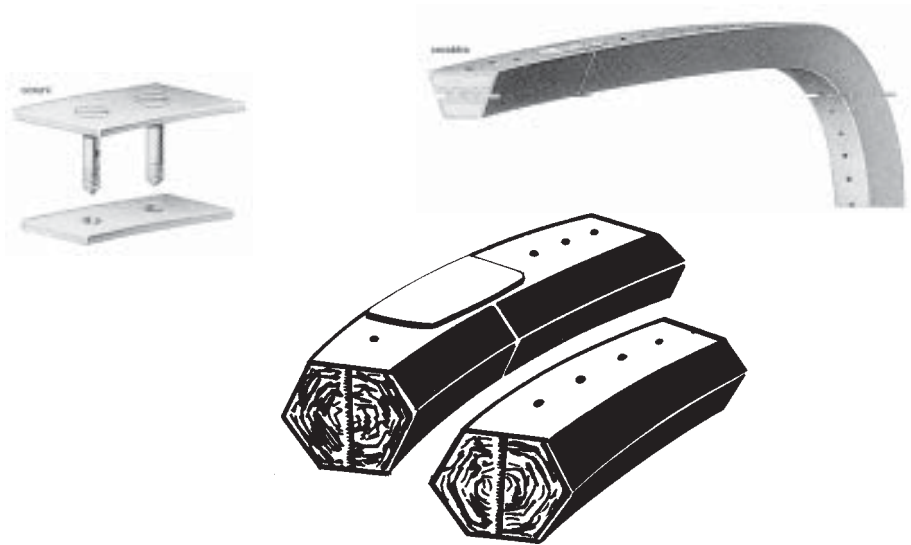

## CORREAS TRAPECIALES ESLABONADAS

Disponibles en los PERFILES: Z - A - B - C

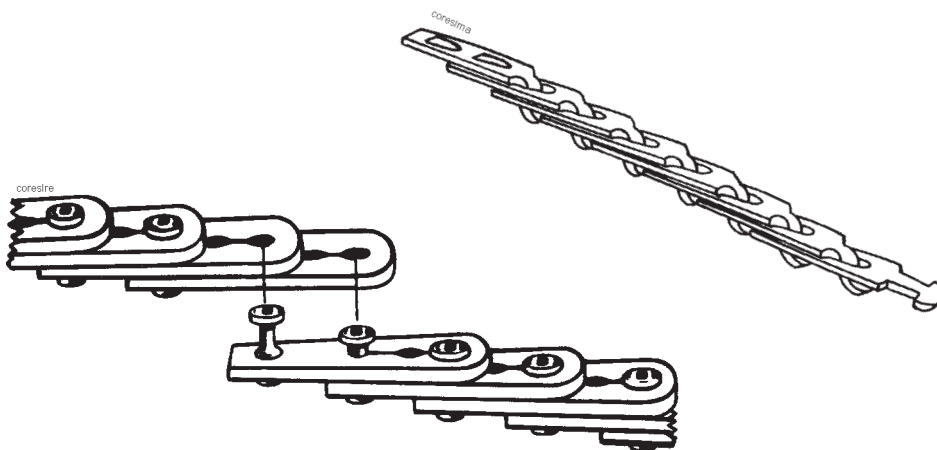

# CORREAS PARA VARIADOR DE VELOCIDAD

WxT mm	ISO	lp mm	$\beta$
13x 6		12	26
17x 5	W 16	16	26
21x 6,5	W 20	20	26
22x 8		21	26
26x 8	W 25	25	26
28x 8		27	26
28x10		27	26
33x10	W 31,5	31,5	26
36x10		35	30
36x12		34,5	30
42x13	W 40	40	30
46x13		44,5	30
52x16	W 50	50	30
54x16		52	30
65x20	W 63	63	30
70x20		68	30
83x25	W 80	80	30
104x32	W100	100	30

Nota: Las secciones W corresponden a la norma ISO R 1604.

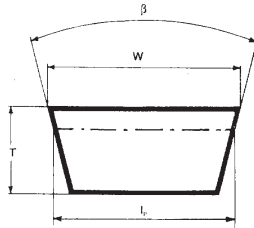

		Espesor de la correa										
$\Delta$		5	6	6,5	8	10	12	13	16	20	25	32
x'		8	9	10	12	16	19	21	25	31	40	50
x''		24	29	31	38	47	56	61	75	94	120	151

Nota: los desarrollos interiores indicados en la tarifa a título indicativo, están redondeados.

$$L_a = L_w + x' \quad L_i = L_w - x''$$

MEDIDAS Li	REF. ISO Lw
13 x 6 / 400	
13 x 6 / 450	
13 x 6 / 467	
13 x 6 / 475	
13 x 6 / 500	
13 x 6 / 525	
13 x 6 / 550	
13 x 6 / 600	
13 x 6 / 625	
13 x 6 / 650	
13 x 6 / 700	
13 x 6 / 725	
13 x 6 / 750	
13 x 6 / 800	
13 x 6 / 850	
13 x 6 / 900	
13 x 6 / 950	
13 x 6 / 1000	
13 x 6 / 1060	
13 x 6 / 1120	
13 x 6 / 1180	
13 x 6 / 1250	
13 x 6 / 1320	
13 x 6 / 1400	
17 x 6 / 470	16 W - 500
17 x 6 / 500	16 W - 530
17 x 6 / 530	16 W - 560
17 x 6 / 550	16 W - 580
17 x 6 / 570	16 W - 600
17 x 6 / 600	16 W - 630
17 x 6 / 650	16 W - 680
17 x 6 / 700	16 W - 730
17 x 6 / 750	16 W - 780
17 x 6 / 770	16 W - 800
17 x 6 / 800	16 W - 830
17 x 6 / 850	16 W - 880
17 x 6 / 870	16 W - 900
17 x 6 / 900	16 W - 930
17 x 6 / 1000	16 W - 1030

MEDIDAS Li	REF. ISO Lw
17 x 6 / 1060	16 W - 1080
17 x 6 / 1100	16 W - 1130
17 x 6 / 1160	16 W - 1180
17 x 6 / 1200	16 W - 1230
17 x 6 / 1250	16 W - 1280
17 x 6 / 1300	16 W - 1330
21 x 6 / 532	20 W - 560
21 x 6 / 552	20 W - 580
21 x 6 / 602	20 W - 630
21 x 6 / 612	20 W - 640
21 x 6 / 682	20 W - 710
21 x 6 / 702	20 W - 730
21 x 6 / 752	20 W - 780
21 x 6 / 772	20 W - 800
21 x 6 / 802	20 W - 830
21 x 6 / 852	20 W - 880
21 x 6 / 872	20 W - 900
21 x 6 / 902	20 W - 930
21 x 6 / 952	20 W - 980
21 x 6 / 972	20 W - 1000
21 x 6 / 1092	20 W - 1120
21 x 6 / 1222	20 W - 1250
22 x 8 / 400	
22 x 8 / 450	
22 x 8 / 485	
22 x 8 / 500	
22 x 8 / 525	
22 x 8 / 550	
22 x 8 / 575	
22 x 8 / 600	
22 x 8 / 650	
22 x 8 / 700	
22 x 8 / 750	
22 x 8 / 800	
22 x 8 / 850	
22 x 8 / 900	
22 x 8 / 950	

MEDIDAS Li	REF. ISO Lw
22 x 8 / 1000	
22 x 8 / 1060	
22 x 8 / 1120	
22 x 8 / 1180	
22 x 8 / 1250	
22 x 8 / 1320	
22 x 8 / 1400	
22 x 8 / 1500	
22 x 8 / 1600	
22 x 8 / 1700	
22 x 8 / 1800	
26 x 8 / 525	25 W - 560
26 x 8 / 600	
26 x 8 / 630	25 W - 665
26 x 8 / 650	25 W - 690
26 x 8 / 672	25 W - 710
26 x 8 / 680	25 W - 715
26 x 8 / 710	25 W - 745
26 x 8 / 750	25 W - 785
26 x 8 / 762	25 W - 800
26 x 8 / 800	25 W - 835
26 x 8 / 850	25 W - 885
26 x 8 / 862	25 W - 900
26 x 8 / 900	25 W - 935
26 x 8 / 962	25 W - 1000
26 x 8 / 1000	25 W - 1035
26 x 8 / 1060	
26 x 8 / 1082	25 W - 1120
26 x 8 / 1120	25 W - 1155
26 x 8 / 1212	25 W - 1250
26 x 8 / 1362	25 W - 1400
26 x 8 / 1562	25 W - 1600
26 x 8 / 1615	25 W - 1650

MEDIDAS Li	REF. ISO Lw
28 x 8 / 525	
28 x 8 / 550	
28 x 8 / 600	
28 x 8 / 630	
28 x 8 / 650	
28 x 8 / 675	
28 x 8 / 700	
28 x 8 / 750	
28 x 8 / 800	
28 x 8 / 850	
28 x 8 / 900	
28 x 8 / 950	
28 x 8 / 1000	
28 x 8 / 1060	
28 x 8 / 1120	
28 x 8 / 1180	
28 x 8 / 1250	
28 x 8 / 1320	
28 x 8 / 1400	
28 x 8 / 1500	
28 x 8 / 1600	
28 x 8 / 1700	
28 x 8 / 1800	
28 x 8 / 1900	
28 x 8 / 2000	
28 x 8 / 2240	
28 x 8 / 2500	
32 x 10 / 710	
32 x 10 / 750	31.5 W-800
32 x 10 / 790	31.5 W-840
32 x 10 / 820	31.5 W-870
32 x 10 / 850	31.5 W-900
32 x 10 / 900	31.5 W-950
32 x 10 / 950	31.5 W-1000
32 x 10 / 1000	31.5 W-1050
32 x 10 / 1060	
32 x 10 / 1073	31.5 W-1120
32 x 10 / 1120	31.5 W-1170
32 x 10 / 1180	31.5 W-1230
32 x 10 / 1203	31.5 W-1250
32 x 10 / 1250	31.5 W-1300
32 x 10 / 1320	
32 x 10 / 1353	31.5 W-1400
32 x 10 / 1400	31.5 W-1450
32 x 10 / 1500	
32 x 10 / 1553	31.5 W-1600
32 x 10 / 1600	31.5 W-1650
32 x 10 / 1700	
32 x 10 / 1753	31.5 W-1800
32 x 10 / 1953	31.5 W-2000
37 x 10 / 600	
37 x 10 / 650	
37 x 10 / 675	
37 x 10 / 700	
37 x 10 / 725	
37 x 10 / 750	
37 x 10 / 800	
37 x 10 / 825	
37 x 10 / 850	
37 x 10 / 900	
37 x 10 / 950	
37 x 10 / 1000	
37 x 10 / 1060	

MEDIDAS Li	REF. ISO Lw
37 x 10 / 1100	
37 x 10 / 1120	
37 x 10 / 1180	
37 x 10 / 1250	
37 x 10 / 1320	
37 x 10 / 1400	
37 x 10 / 1500	
37 x 10 / 1600	
37 x 10 / 1632	
37 x 10 / 1700	
37 x 10 / 1800	
37 x 10 / 1900	
37 x 10 / 2000	
37 x 10 / 2050	
37 x 10 / 2240	
37 x 10 / 2500	
37 x 10 / 2800	
42 x 12 / 900	40 W - 955
42 x 12 / 925	40 W - 980
42 x 12 / 938	40 W - 1000
42 x 12 / 1000	40 W - 1060
42 x 12 / 1064	40 W - 1120
42 x 12 / 1120	40 W - 1180
42 x 12 / 1194	40 W - 1250
42 x 12 / 1250	40 W - 1305
42 x 12 / 1320	
42 x 12 / 1344	40 W - 1400
42 x 12 / 1400	40 W - 1455
42 x 12 / 1444	40 W - 1500
42 x 12 / 1544	40 W - 1600
42 x 12 / 1600	40 W - 1655
42 x 12 / 1700	40 W - 1775
42 x 12 / 1800	40 W - 1855
42 x 12 / 2000	40 W - 2055
42 x 12 / 2184	40 W - 2240
42 x 12 / 2444	40 W - 2500
47 x 12 / 800	
47 x 12 / 850	
47 x 12 / 880	
47 x 12 / 900	
47 x 12 / 950	
47 x 12 / 1000	
47 x 12 / 1035	
47 x 12 / 1060	
47 x 12 / 1120	
47 x 12 / 1180	
47 x 12 / 1250	
47 x 12 / 1320	
47 x 12 / 1400	
47 x 12 / 1500	
47 x 12 / 1600	
47 x 12 / 1700	
47 x 12 / 1800	
47 x 12 / 2000	
47 x 12 / 2240	
47 x 12 / 2500	
47 x 12 / 2800	
47 x 12 / 3150	

MEDIDAS Li	REF. ISO Lw
50 x 16 / 1453	
50 x 16 / 1505	
52 x 16 / 1045	50 W - 1120
52 x 16 / 1179	50 W - 1250
52 x 16 / 1324	50 W - 1400
52 x 16 / 1524	50 W - 1600
52 x 16 / 1599	50 W - 1675
52 x 16 / 1724	50 W - 1800
52 x 16 / 1924	50 W - 2000
52 x 16 / 2164	50 W - 2240
52 x 16 / 2424	50 W - 2500
52 x 16 / 2724	50 W - 2800
52 x 16 / 3074	50 W - 3150
55 x 16 / 900	
55 x 16 / 1000	
55 x 16 / 1100	
55 x 16 / 1150	
55 x 16 / 1180	
55 x 16 / 1250	
55 x 16 / 1320	
55 x 16 / 1400	
55 x 16 / 1500	
55 x 16 / 1600	
55 x 16 / 1700	
55 x 16 / 1800	
55 x 16 / 2000	
55 x 16 / 2240	
55 x 16 / 2500	
55 x 16 / 2800	
58 x 17 / 1500	
58 x 17 / 1600	
58 x 17 / 1700	
58 x 17 / 1800	
58 x 17 / 2000	
58 x 17 / 2240	
58 x 17 / 2500	
58 x 17 / 2800	
65 x 20 / 1506	63 W - 1600
65 x 20 / 1706	63 W - 1800
65 x 20 / 1906	63 W - 2000
65 x 20 / 2146	63 W - 2240
65 x 20 / 2406	63 W - 2500
65 x 20 / 2706	63 W - 2800
65 x 20 / 3056	63 W - 3150
65 x 20 / 3456	63 W - 3550
65 x 20 / 3906	63 W - 4000
70 x 18 / 1320	
70 x 18 / 1400	
70 x 18 / 1500	
70 x 18 / 1600	
70 x 18 / 1700	
70 x 18 / 1800	
70 x 18 / 1900	
70 x 18 / 2000	
70 x 18 / 2240	
70 x 18 / 2500	
70 x 18 / 2800	

MEDIDAS Li	REF. ISO Lw				
70 x 18 / 3150 70 x 18 / 3210 70 x 18 / 3520					
70 x 20 / 1600 70 x 20 / 1700 70 x 20 / 1800 70 x 20 / 2000 70 x 20 / 2240 70 x 20 / 2500 70 x 20 / 2800					
72 x 20 / 1600 72 x 20 / 1700 72 x 20 / 1800 72 x 20 / 2000 72 x 20 / 2240 72 x 20 / 2400 72 x 20 / 2500 72 x 20 / 2800 72 x 20 / 3150					
83 x 23 / 1691 83 x 23 / 1891 83 x 23 / 2131 83 x 23 / 2391 83 x 23 / 2691 83 x 23 / 3041 83 x 23 / 3441 83 x 23 / 3891	80 W - 1800 80 W - 2000 80 W - 2240 80 W - 2500 80 W - 2800 80 W - 3150 80 W - 3550 80 W - 4000				
98 x 23 / 1692 98 x 23 / 1855					
99 x 23 / 2110					



## CORREAS Y CORDON TERMOSOLDABLES

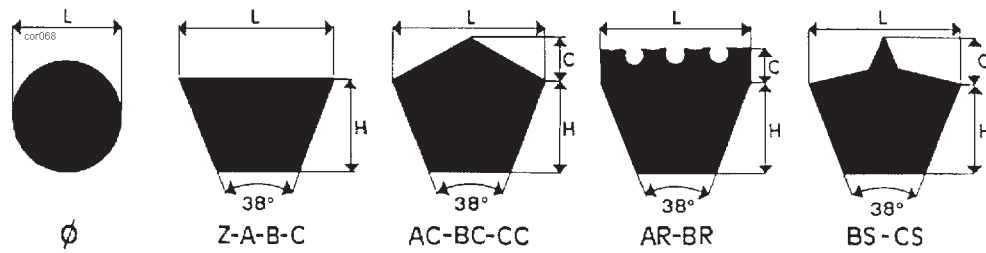

TIPO	ANCHO L	ALTURA C	ALTURA H	Ø POLEA MINIMO	TENSION %	PESO g/m
3	3	-	-	25	12	10
4	4	-	-	35	10	15
5	5	-	-	45	9	23
6	6	-	-	50	9	34
8	8	-	-	80	8	59
10	10	-	-	80	7	95
12	12	-	-	100	7	136
15	15	-	-	120	6	212
Z	10	6	-	70	10	68
A	13	8	-	100	9	96
B	17	11	-	125	8	172
C	22	14	-	160	6	286
AC	13	8	7	90	8	195
BC	17	11	10	160	7	274
CC	22	14	15	200	5	431
AR	13	8	5	110	8	190
BR	17	11	5	150	7	270
BS	17	11	10	160	7	270
CS	22	14	15	200	5	400

Dimensiones en mm. Secciones de acuerdo con normas ISO R52-ISO R253 DIN 2.215.

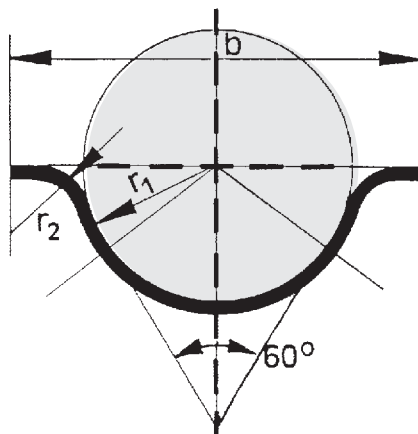

TIPO	r <sub>1</sub>	r <sub>2</sub>	b
3	1,0	1,8	8
4	1,0	2,3	10
5	1,0	2,9	12
6	1,5	3,4	14
8	1,5	4,4	16
10	2,0	5,5	20
12	2,0	6,5	25
15	2,0	8,0	30

## CORREAS PLANAS SINFIN PARA ALTA VELOCIDAD



<b>M E D I D A S</b>			
240	950	1530	2260
300	960	1550	2280
330	970	1560	2300
370	980	1590	2320
400	990	1610	2330
420	1000	1630	2350
450	1010	1640	2370
460	1020	1650	2400
480	1030	1670	2420
500	1040	1680	2450
520	1050	1700	2500
540	1060	1730	2520
560	1070	1760	2550
580	1080	1775	2600
600	1090	1790	2620
610	1110	1820	2650
620	1130	1850	2700
640	1150	1880	2720
650	1160	1900	2800
660	1180	1920	2900
680	1190	1930	3000
700	1200	1940	3100
720	1210	1950	3160
740	1230	1970	3200
750	1240	2000	3300
770	1260	2020	3400
790	1270	2040	3500
800	1300	2050	3600
810	1320	2060	
830	1340	2070	
840	1350	2100	
850	1360	2110	
860	1380	2120	
870	1400	2130	
880	1420	2150	
890	1140	2200	
910	1450	2220	
930	1480	2230	
940	1500	2250	

## CORREAS DENTADAS EN NEOPRENO PASO MXL

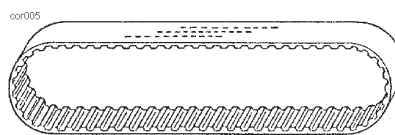
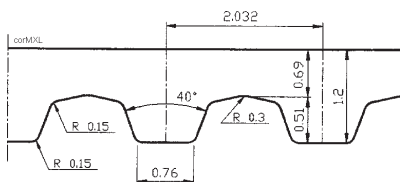

CODIGO	DTES.	MM.	CODIGO	DTES.	MM.	CODIGO	DTES.	MM.
cor007								
41-MXL	41	83,31	122-MXL	122	247,90	281-MXL	281	570,99
45-MXL	45	91,44	123-MXL	123	249,94	290-MXL	290	589,28
46-MXL	46	93,47	125-MXL	125	254,00	295-MXL	295	599,44
48-MXL	48	97,54	126-MXL	126	256,03	300-MXL	300	609,60
50-MXL	50	101,60	127-MXL	127	258,06	305-MXL	305	619,76
51-MXL	51	103,63	128-MXL	128	260,10	310-MXL	310	629,92
52-MXL	52	105,66	129-MXL	129	262,12	312-MXL	312	633,98
53-MXL	53	107,70	130-MXL	130	264,16	315-MXL	315	640,08
54-MXL	54	109,73	131-MXL	131	266,19	320-MXL	320	650,24
55-MXL	55	111,76	132-MXL	132	268,22	324-MXL	324	658,37
56-MXL	56	113,79	134-MXL	134	272,28	330-MXL	330	670,56
59-MXL	59	119,89	135-MXL	135	274,32	332-MXL	332	674,62
60-MXL	60	121,92	138-MXL	138	280,42	336-MXL	336	682,75
61-MXL	61	123,95	140-MXL	140	284,48	337-MXL	337	684,78
63-MXL	63	128,02	142-MXL	142	288,54	338-MXL	338	686,82
65-MXL	65	132,08	144-MXL	144	292,61	339-MXL	339	688,85
67-MXL	67	136,14	146-MXL	146	296,67	348-MXL	348	707,13
68-MXL	68	138,18	147-MXL	147	298,70	350-MXL	350	711,20
71-MXL	71	144,27	150-MXL	150	304,80	355-MXL	355	721,36
72-MXL	72	146,30	152-MXL	152	308,86	356-MXL	356	723,39
73-MXL	73	148,34	154-MXL	154	312,92	359-MXL	359	729,49
75-MXL	75	152,40	155-MXL	155	314,96	364-MXL	364	739,64
76-MXL	76	154,43	158-MXL	158	321,06	365-MXL	365	741,68
77-MXL	77	156,46	160-MXL	160	325,12	372-MXL	372	755,90
78-MXL	78	158,49	162-MXL	162	329,18	380-MXL	380	772,16
79-MXL	79	160,53	165-MXL	165	335,28	386-MXL	386	784,35
80-MXL	80	162,56	170-MXL	170	345,44	397-MXL	397	806,70
81-MXL	81	164,59	175-MXL	175	355,60	400-MXL	400	812,80
82-MXL	82	166,62	180-MXL	180	365,76	405-MXL	405	822,96
83-MXL	83	168,66	184-MXL	184	373,89	419-MXL	419	851,41
85-MXL	85	172,72	185-MXL	185	375,92	424-MXL	424	861,56
87-MXL	87	176,78	187-MXL	187	379,98	435-MXL	435	883,92
88-MXL	88	180,84	190-MXL	190	386,08	436-MXL	436	885,95
89-MXL	89	180,84	195-MXL	195	396,24	438-MXL	438	890,02
90-MXL	90	182,88	200-MXL	200	406,40	448-MXL	448	910,33
91-MXL	91	184,91	205-MXL	205	416,56	453-MXL	453	920,50
92-MXL	92	186,94	210-MXL	210	426,72	464-MXL	464	942,85
93-MXL	93	188,98	212-MXL	212	430,78	478-MXL	478	971,30
94-MXL	94	191,01	219-MXL	219	445,00	487-MXL	487	989,58
95-MXL	95	193,04	220-MXL	220	447,04	498-MXL	498	1011,94
97-MXL	97	197,10	224-MXL	224	455,17	500-MXL	500	1016,00
98-MXL	98	199,14	227-MXL	227	461,26	503-MXL	503	1022,09
100-MXL	100	203,20	228-MXL	228	463,30	515-MXL	515	1046,48
101-MXL	101	205,23	232-MXL	232	471,42	520-MXL	520	1056,64
102-MXL	102	207,26	236-MXL	236	479,55	535-MXL	535	1087,12
103-MXL	103	209,30	239-MXL	239	485,65	537-MXL	537	1091,18
105-MXL	105	213,36	240-MXL	240	487,68	550-MXL	550	1117,60
106-MXL	106	215,39	250-MXL	250	508,00	569-MXL	569	1156,20
110-MXL	110	223,52	256-MXL	256	520,19	705-MXL	705	1432,56
112-MXL	112	227,58	262-MXL	262	532,38			
114-MXL	114	231,65	265-MXL	265	538,48			
115-MXL	115	233,68	270-MXL	270	548,64			
118-MXL	118	239,78	273-MXL	273	554,73			
120-MXL	120	243,84	278-MXL	278	564,89			
121-MXL	121	245,87	280-MXL	280	568,96			

ANCHURAS STANDARD: 3,2 mm - 4,8 mm - 6,4 mm - 7,9 mm - 9,5 mm

# CORREAS DENTADAS EN NEOPRENO PASO XL

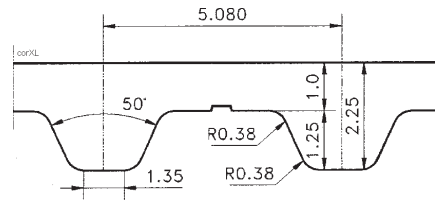
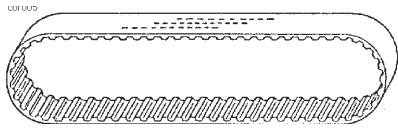

CODIGO	DTES.	MM.	CODIGO	DTES.	MM.
<small>cor009</small>					
60-XL	30	152,40	188-XL	94	477,52
64-XL	32	162,56	190-XL	95	482,60
68-XL	34	172,72	192-XL	96	487,68
70-XL	35	177,80	196-XL	98	497,84
76-XL	38	193,04	198-XL	99	502,92
80-XL	40	203,20	200-XL	100	508,00
82-XL	41	208,28	204-XL	102	518,16
84-XL	42	213,36	206-XL	103	523,24
86-XL	43	218,44	210-XL	105	533,40
88-XL	44	223,52	212-XL	106	538,48
90-XL	45	228,60	216-XL	108	548,64
92-XL	46	233,68	220-XL	110	558,80
94-XL	47	238,76	230-XL	115	584,20
96-XL	48	243,84	234-XL	117	594,36
98-XL	49	248,92	240-XL	120	609,60
100-XL	50	254,00	250-XL	125	635,00
102-XL	51	259,08	254-XL	127	645,16
104-XL	52	264,16	260-XL	130	660,40
108-XL	54	274,32	270-XL	135	685,80
110-XL	55	279,40	276-XL	138	701,04
112-XL	56	284,48	282-XL	141	716,28
114-XL	57	289,56	290-XL	145	736,60
116-XL	58	294,64	300-XL	150	762,00
118-XL	59	299,72	310-XL	155	787,40
120-XL	60	304,80	314-XL	157	797,56
122-XL	61	309,88	320-XL	160	812,80
124-XL	62	314,96	330-XL	165	838,20
126-XL	63	320,04	332-XL	166	843,28
128-XL	64	325,12	340-XL	170	863,60
130-XL	65	330,20	348-XL	174	883,92
134-XL	67	340,36	352-XL	176	894,08
136-XL	68	345,44	360-XL	180	914,40
138-XL	69	350,52	376-XL	188	955,04
140-XL	70	355,60	384-XL	192	975,36
142-XL	71	360,68	390-XL	195	990,60
144-XL	72	365,76	396-XL	198	1005,84
146-XL	73	370,84	424-XL	212	1076,96
148-XL	74	375,92	460-XL	230	1168,40
150-XL	75	381,00	478-XL	239	1214,12
152-XL	76	386,08	490-XL	245	1244,60
156-XL	78	396,24	522-XL	261	1325,88
158-XL	79	401,32	532-XL	266	1351,28
160-XL	80	406,60	552-XL	276	1420,08
162-XL	81	411,48	564-XL	282	1432,56
164-XL	82	416,56	600-XL	300	1524,00
166-XL	83	421,64	616-XL	308	1564,64
170-XL	85	431,80	630-XL	315	1600,20
172-XL	86	436,88	670-XL	335	1701,80
174-XL	87	441,96	828-XL	414	2103,12
176-XL	88	447,04	860-XL	430	2184,40
178-XL	89	452,12			
180-XL	90	457,20			
182-XL	91	462,28			
184-XL	92	467,36			
186-XL	93	472,44			

ANCHURAS STANDARD: 0,25 (6,4 mm) - 0,31 (7,9 mm) - 0,37 (9,4 mm) - 0,50 (12,7 mm)

## CORREAS DENTADAS EN NEOPRENO

### PASO L

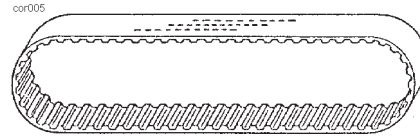
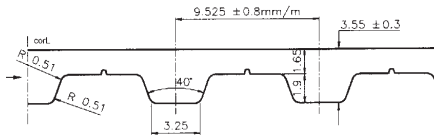

CODIGO	DTES.	MM.	CODIGO	DTES.	MM.
cor030					
109-L	29	276,23	367-L	98	933,45
124-L	33	314,32	375-L	100	952,50
135-L	36	342,90	382-L	102	971,55
150-L	40	381,00	390-L	104	990,60
165-L	44	419,10	394-L	105	1000,13
173-L	46	438,15	398-L	106	1009,65
187-L	50	476,25	420-L	112	1066,80
210-L	56	533,40	427-L	114	1084,58
217-L	58	552,45	436-L	116	1104,90
225-L	60	571,50	450-L	120	1143,00
232-L	62	590,55	454-L	121	1152,53
240-L	64	609,60	480-L	128	1219,20
255-L	68	647,70	510-L	136	1295,40
265-L	71	676,28	525-L	140	1333,50
270-L	72	685,80	540-L	144	1371,60
277-L	74	704,85	548-L	146	1390,65
285-L	76	723,90	550-L	147	1400,18
300-L	80	762,00	581-L	155	1476,38
320-L	85	809,63	600-L	160	1524,10
322-L	86	819,15	630-L	168	1600,20
334-L	89	847,73	653-L	174	1657,35
337-L	90	857,25	660-L	176	1676,40
345-L	92	876,30	697-L	186	1771,65
360-L	96	914,40	731-L	195	1857,38
			934-L	249	2371,73

ANCHOS STANDARD: 0,50 (12,7 mm) - 0,75 (19,1 mm) - 100 (25,4 mm) - 150 (38,1 mm)

## CORREAS DENTADAS EN NEOPRENO PASO H

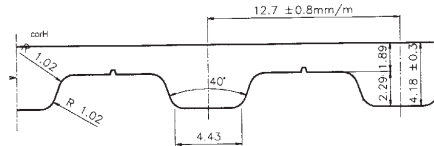
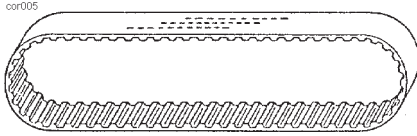

CODIGO	DTES.	MM.	CODIGO	DTES.	MM.
<small>cor029</small>					
225-H	45	571,50	560-H	112	1422,40
230-H	46	584,20	565-H	113	1435,10
240-H	48	609,60	570-H	114	1447,80
245-H	49	622,30	600-H	120	1524,00
255-H	51	647,70	625-H	125	1587,50
270-H	54	685,80	630-H	126	1600,20
300-H	60	762,00	650-H	130	1651,00
310-H	62	787,40	660-H	132	1676,40
315-H	63	800,10	680-H	136	1727,20
320-H	64	812,80	700-H	140	1778,00
330-H	66	838,20	750-H	150	1905,00
350-H	70	889,00	770-H	154	1955,80
360-H	72	914,40	800-H	160	2032,00
370-H	74	939,80	810-H	162	2057,50
375-H	75	952,50	840-H	168	2133,60
390-H	78	990,60	850-H	170	2159,00
400-H	80	1016,00	880-H	176	2235,20
410-H	82	1041,40	900-H	180	2286,00
420-H	84	1066,80	950-H	190	2413,00
430-H	86	1092,20	1000-H	200	2540,00
450-H	90	1143,00	1100-H	220	2794,00
465-H	93	1181,10	1130-H	226	2870,20
480-H	96	1219,20	1250-H	250	3175,00
490-H	98	1244,60	1360-H	272	3454,40
510-H	102	1295,40	1400-H	280	3556,00
530-H	106	1346,20	1700-H	340	4318,00
540-H	108	1371,60			

ANCHOS STANDARD: 0,75 (19,1 mm) - 100 (25,4 mm) - 150 (38,1 mm)  
200 (50,8 mm) - 300 (76,2 mm)



## CORREAS DENTADAS EN NEOPRENO PASO XH

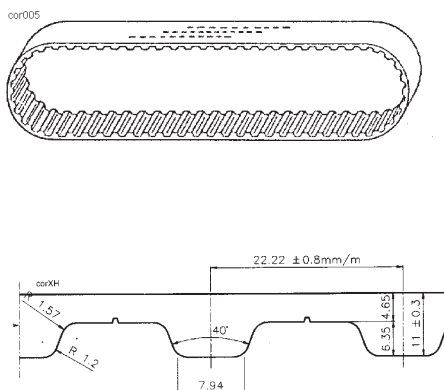

ANCHURAS STANDAR:

200 ( 50,8 mm) - 300 ( 76,2 mm)  
400 (101,6 mm) - 500 (127,0 mm)

cor031					
CODIGO	DTES.	MM.	CODIGO	DTES.	MM.
463-XH	53	1177,93	1120-XH	128	2844,80
507-XH	58	1287,78	1260-XH	144	3200,00
560-XH	64	1422,40	1400-XH	160	3556,00
630-XH	72	1600,20	1540-XH	176	3911,60
700-XH	80	1778,00	1750-XH	200	4445,00
770-XH	88	1955,80			
840-XH	96	2133,60			
927-XH	102	2355,85			
980-XH	112	2489,20			

## CORREAS DENTADAS EN NEOPRENO PASO XXH

cor032		
CODIGO	DTES.	MM.
700-XXH	56	1778,00
800-XXH	64	2032,00
900-XXH	72	2286,00
1000-XXH	80	2540,00
1200-XXH	96	3048,00
1400-XXH	112	3556,00
1600-XXH	128	4064,00
1800-XXH	144	4572,00

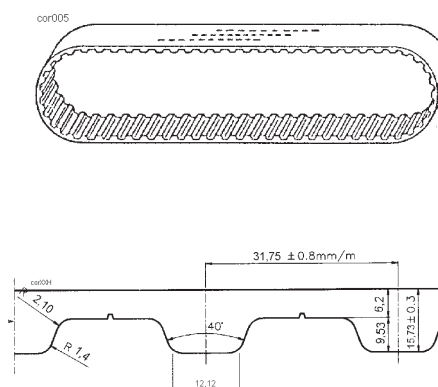

ANCHURAS STANDAR:

200 ( 50,8 mm) - 300 ( 76,2 mm)  
400 (101,6 mm) - 500 (127,0 mm)  
600 (152,4 mm)

## CORREAS DOBLE DENTADO EN NEOPRENO PASO XL - DL

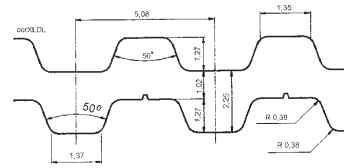

CODIGO	DTES.	MM.	CODIGO	DTES.	MM.	CODIGO	DTES.	MM.
D150-XL	75	381,00	D198-XL	99	502,92	D290-XL	145	736,60
D152-XL	76	386,08	D200-XL	100	508,00	D300-XL	150	762,00
D156-XL	78	396,24	D204-XL	102	518,16	D314-XL	157	797,56
D160-XL	80	406,60	D206-XL	103	523,24	D320-XL	160	812,80
D162-XL	81	411,48	D210-XL	105	533,40	D330-XL	165	838,20
D164-XL	82	416,56	D212-XL	106	538,48	D340-XL	170	863,60
D166-XL	83	421,64	D220-XL	110	558,80	D348-XL	174	883,92
D170-XL	85	431,80	D230-XL	115	584,20	D352-XL	176	894,08
D176-XL	88	447,04	D234-XL	117	594,36	D360-XL	180	914,40
D178-XL	89	452,12	D240-XL	120	609,60			
D180-XL	90	457,20	D250-XL	125	635,00			
D182-XL	91	462,28	D260-XL	130	660,40			
D184-XL	92	467,36	D270-XL	135	685,80			
D188-XL	94	477,52	D276-XL	138	701,04			
D190-XL	95	482,60	D282-XL	141	716,28			

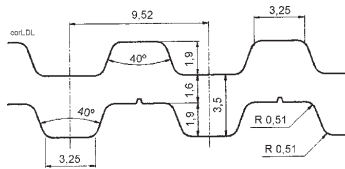

## CORREAS DENTADAS EN NEOPRENO PASO L - DL

CODIGO	DTES.	MM.	CODIGO	DTES.	MM.	CODIGO	DTES.	MM.
D210-L	56	533,40	D337-L	90	857,25	D454-L	121	1152,53
D217-L	58	552,45	D345-L	92	876,30	D480-L	128	1219,20
D225-L	60	571,50	D360-L	96	914,40	D510-L	136	1295,40
D232-L	62	590,55	D367-L	98	933,45	D525-L	140	1333,50
D240-L	64	609,60	D375-L	100	952,50	D540-L	144	1371,60
D255-L	68	647,70	D382-L	102	971,55	D548-L	146	1390,65
D270-L	72	685,80	D390-L	104	990,00	D550-L	147	1400,18
D285-L	76	723,90	D394-L	105	1000,13	D600-L	160	1524,10
D300-L	80	762,00	D420-L	112	1066,88	D630-L	168	1600,20
D320-L	85	809,63	D427-L	114	1084,58	D653-L	174	1657,35
D322-L	86	819,15	D436-L	116	1104,90			
D334-L	89	847,73	D450-L	120	1143,00			

## CORREAS DOBLE DENTADO EN NEOPRENO PASO H - DL

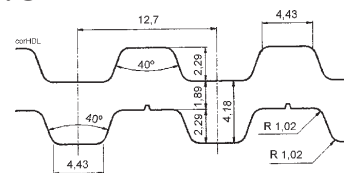

CODIGO	DTES.	MM.	CODIGO	DTES.	MM.	CODIGO	DTES.	MM.
D240-H	48	609,60	D450-H	90	1143,00	D770-H	154	1955,80
D245-H	49	622,30	D465-H	93	1181,10	D800-H	160	2032,00
D255-H	51	647,70	D480-H	96	1219,20	D810-H	162	2057,50
D270-H	54	685,80	D490-H	98	1244,60	D840-H	168	2133,60
D300-H	60	762,00	D510-H	102	1295,40	D850-H	170	2159,00
D310-H	62	787,40	D540-H	108	1371,60	D880-H	176	2235,20
D315-H	63	800,10	D560-H	112	1422,40	D900-H	180	2286,00
D320-H	64	812,80	D565-H	113	1435,10	D950-H	190	2413,00
D330-H	66	838,20	D570-H	114	1447,80	D1000-H	200	2540,00
D350-H	70	889,00	D600-H	120	1524,00	D1100-H	220	2794,00
D360-H	72	914,40	D625-H	125	1587,50	D1130-H	226	2870,20
D375-H	75	952,50	D630-H	126	1600,20	D1250-H	250	3175,00
D390-H	78	990,60	D650-H	130	1651,00	D1400-H	280	3556,00
D400-H	80	1016,00	D660-H	132	1676,40	D1700-H	340	4318,00
D410-H	82	1041,40	D680-H	136	1727,20			
D420-H	84	1066,80	D700-H	140	1778,00			
D430-H	86	1092,20	D750-H	150	1905,00			

## CORREAS DENTADAS EN POLIURETANO PASO T- 2.5

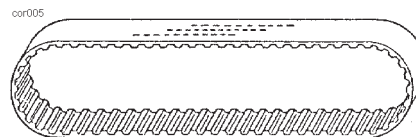
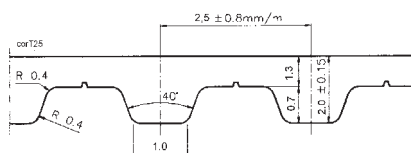

CODIGO	DTES.	MM.	CODIGO	DTES.	MM.	CODIGO	DTES.	MM.
T2,5-120	48	120	T2,5-265	106	265	T2,5-600	240	600
T2,5-145	58	145	T2,5-285	114	285	T2,5-620	248	620
T2,5-160	64	160	T2,5-290	116	290	T2,5-650	260	650
T2,5-177,5	71	177,5	T2,5-317,5	127	317,5	T2,5-780	312	780
T2,5-180	72	180	T2,5-330	132	330			
T2,5-182,5	73	182,5	T2,5-380	152	380			
T2,5-200	80	200	T2,5-420	168	420			
T2,5-230	92	230	T2,5-480	192	480			
T2,5-245	98	245	T2,5-500	200	500			

ANCHOS STANDARD: 6 mm. - 10 mm. - 16 mm. - 25 mm.

## CORREAS DENTADAS EN POLIURETANO PASO T - 5

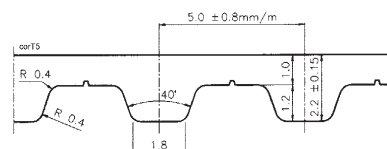
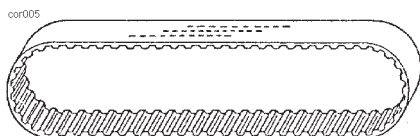

CODIGO	DTES.	MM.	CODIGO	DTES.	MM.	CODIGO	DTES.	MM.
T5-100	20	100	T5-365	73	365	T5-700	140	700
T5-150	30	150	T5-390	78	390	T5-720	144	720
T5-165	33	165	T5-400	80	400	T5-725	145	725
T5-180	36	180	T5-410	82	410	T5-750	150	750
T5-185	37	185	T5-420	84	420	T5-765	153	765
T5-200	40	200	T5-455	91	455	T5-780	156	780
T5-210	42	210	T5-480	96	480	T5-800	160	800
T5-215	43	215	T5-500	100	500	T5-815	163	815
T5-220	44	220	T5-510	102	510	T5-840	168	840
T5-225	45	225	T5-525	105	525	T5-900	172	900
T5-245	49	245	T5-545	109	545	T5-920	184	920
T5-255	51	255	T5-550	110	550	T5-925	185	925
T5-260	52	260	T5-560	112	560	T5-940	188	940
T5-270	54	270	T5-575	115	575	T5-990	198	990
T5-280	56	280	T5-590	118	590	T5-1075	215	1075
T5-295	59	295	T5-600	120	600	T5-1100	220	1100
T5-305	61	305	T5-610	122	610	T5-1160	232	1160
T5-330	66	330	T5-620	124	620	T5-1215	243	1215
T5-340	68	340	T5-630	126	630	T5-1315	263	1315
T5-355	71	355	T5-690	138	690	T5-1380	276	1380

ANCHOS STANDARD: 6 mm. - 10 mm. - 16 mm. - 25 mm.

## CORREAS DENTADAS EN POLIURETANO PASO T - 10

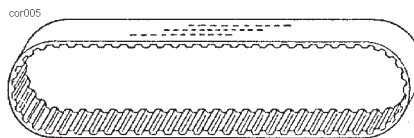
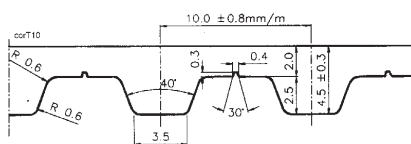

CODIGO	DTES.	MM.	CODIGO	DTES.	MM.	CODIGO	DTES.	MM.
T10-260	26	260	T10-810	81	810	T10-1320	132	1320
T10-370	37	370	T10-840	84	840	T10-1350	135	1350
T10-410	41	410	T10-850	85	850	T10-1390	139	1390
T10-440	44	440	T10-880	88	880	T10-1400	140	1400
T10-500	50	500	T10-890	89	890	T10-1420	142	1420
T10-530	53	530	T10-920	92	920	T10-1450	145	1450
T10-560	56	560	T10-960	96	960	T10-1460	146	1460
T10-600	60	600	T10-970	97	970	T10-1500	150	1500
T10-610	61	610	T10-980	98	980	T10-1560	156	1560
T10-630	63	630	T10-1010	101	1010	T10-1610	161	1610
T10-660	66	660	T10-1080	108	1080	T10-1750	175	1750
T10-680	68	680	T10-1110	111	1110	T10-1780	178	1780
T10-690	69	690	T10-1140	114	1140	T10-1880	188	1880
T10-700	70	700	T10-1150	115	1150	T10-1960	196	1960
T10-720	72	720	T10-1210	121	1210	T10-2250	225	2250
T10-730	73	730	T10-1240	123	1240	T10-3100	310	3100
T10-750	75	750	T10-1250	125	1250	T10-4780	478	4780
T10-780	78	780	T10-1300	130	1300			

ANCHOS STANDARD: 16 mm. - 20 mm. - 25 mm. - 32 mm. - 50 mm.

## CORREAS DENTADAS EN POLIURETANO PASO T - 20

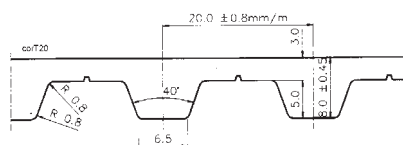
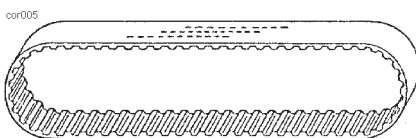

CODIGO	DTES.	MM.	CODIGO	DTES.	MM.	CODIGO	DTES.	MM.
T20-1260	63	1260	T20-1880	94	1880	T20-3100	155	3100
T20-1460	73	1460	T20-2360	118	2360	T20-3620	181	3620
T20-1780	89	1780	T20-2600	130	2600			

## CORREA DOBLE DENTADO EN POLIURETANO PASO T - 5 - DL

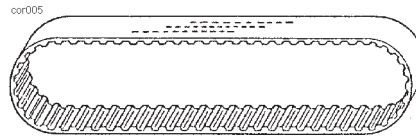
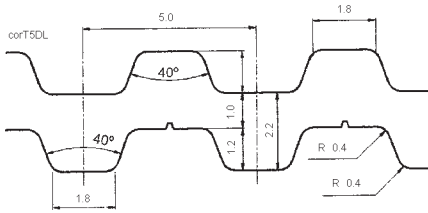

CODIGO	DTES.	MM.	CODIGO	DTES.	MM.	CODIGO	DTES.	MM.
cor045								
T5-150-DL	30	150	T5-515-DL	103	515	T5-815-DL	163	815
T5-260-DL	52	260	T5-590-DL	118	590	T5-860-DL	172	860
T5-300-DL	60	300	T5-620-DL	124	620	T5-940-DL	188	940
T5-410-DL	82	410	T5-625-DL	125	625	T5-1100-DL	220	1100
T5-460-DL	92	460	T5-750-DL	150	750	T5-1325-DL	265	1325

## CORREA DOBLE DENTADO EN POLIURETANO PASO T - 10 - DL

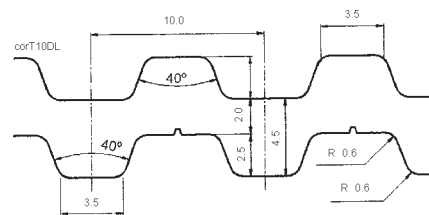
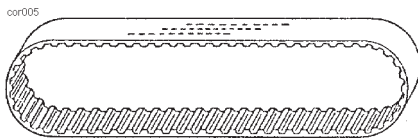

CODIGO	DTES.	MM.	CODIGO	DTES.	MM.	CODIGO	DTES.	MM.
cor053								
T10-260-DL	26	260	T10-980-DL	98	980	T10-1350-DL	135	1350
T10-530-DL	53	530	T10-1210-DL	121	1210	T10-1420-DL	142	1420
T10-630-DL	63	630	T10-1240-DL	124	1240	T10-1610-DL	161	1610
T10-660-DL	66	660	T10-1250-DL	125	1250	T10-1880-DL	188	1880
T10-720-DL	72	720	T10-1320-DL	132	1320	T10-4780-DL	478	4780
T10-840-DL	84	840						

## CORREA DOBLE DENTADO EN POLIURETANO PASO T - 20 - DL

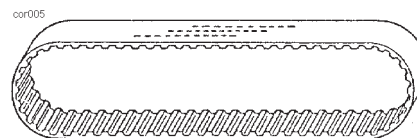
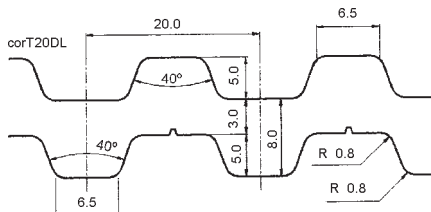

CODIGO	DTES.	MM.	CODIGO	DTES.	MM.	CODIGO	DTES.	MM.
cor053								
T20-2600-DL	130	2600	T20-3620-DL	181	3620			

## CORREAS DENTADAS EN POLIURETANO PASO AT-5

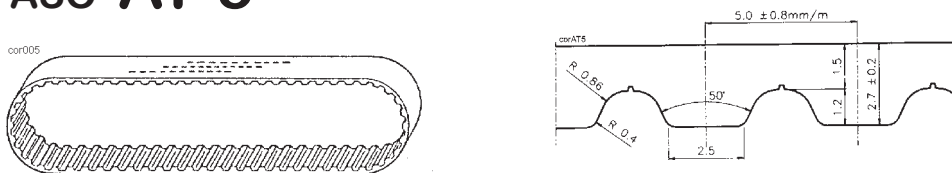

CODIGO	DTES.	MM.	CODIGO	DTES.	MM.	CODIGO	DTES.	MM.
AT5-225	45	225	AT5-450	90	450	AT5-710	142	710
AT5-255	51	255	AT5-455	91	455	AT5-720	144	720
AT5-260	52	260	AT5-480	96	480	AT5-750	150	750
AT5-280	56	280	AT5-500	100	500	AT5-780	156	780
AT5-300	60	300	AT5-525	105	525	AT5-825	165	825
AT5-330	66	330	AT5-545	109	545	AT5-975	195	975
AT5-340	68	340	AT5-600	120	600	AT5-1050	210	1050
AT5-375	75	375	AT5-610	122	610	AT5-1125	225	1125
AT5-390	78	390	AT5-620	124	620	AT5-1500	300	1500
AT5-420	84	420	AT5-660	132	660	AT5-1750	350	1750
						AT5-2000	400	2000

## CORREAS DENTADAS EN POLIURETANO PASO AT-10

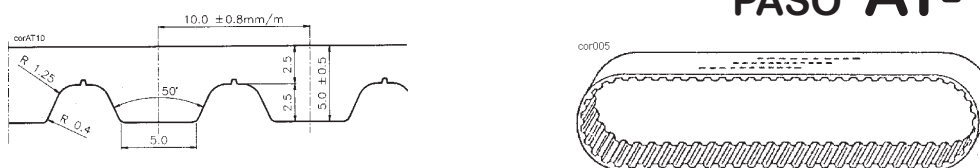

CODIGO	DTES.	MM.	CODIGO	DTES.	MM.	CODIGO	DTES.	MM.
AT10-500	50	500	AT10-1010	101	1010	AT10-1360	136	1360
AT10-560	56	560	AT10-1050	105	1050	AT10-1400	140	1400
AT10-600	60	600	AT10-1080	108	1080	AT10-1480	148	1480
AT10-610	61	610	AT10-1100	110	1100	AT10-1500	150	1500
AT10-660	66	660	AT10-1150	115	1150	AT10-1600	160	1600
AT10-700	70	700	AT10-1200	120	1200	AT10-1700	170	1700
AT10-730	73	730	AT10-1210	121	1210	AT10-1720	172	1720
AT10-780	78	780	AT10-1250	125	1250	AT10-1800	180	1800
AT10-800	80	800	AT10-1280	128	1280	AT10-1860	186	1860
AT10-840	84	840	AT10-1300	130	1300	AT10-1940	194	1940
AT10-890	89	890	AT10-1320	132	1320			
AT10-1000	100	1000	AT10-1350	135	1350			

## CORREAS DENTADAS EN POLIURETANO PASO AT-20

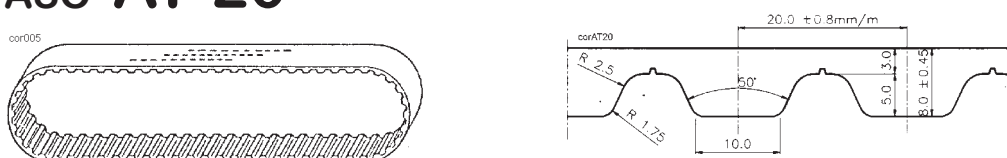

CODIGO	DTES.	MM.	CODIGO	DTES.	MM.	CODIGO	DTES.	MM.
AT20-1000	50	1000	AT20-1500	75	1500	AT20-1800	90	1800
AT20-1100	55	1100	AT20-1600	80	1600	AT20-1900	95	1900
AT20-1200	60	1200	AT20-1700	85	1700	AT20-1960	98	1960
AT20-1260	63	1260	AT20-1760	88	1760			

## CORREAS DENTADAS EN POLIURETANO PASO **AR** (4.706)

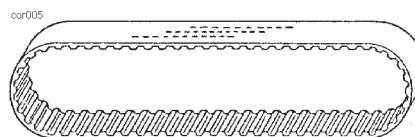
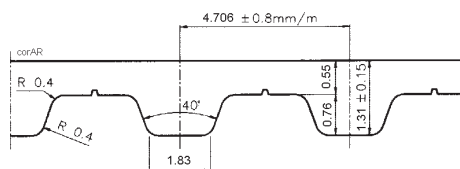

CODIGO	DTES.	MM.	CODIGO	DTES.	MM.	CODIGO	DTES.	MM.
AR-28	28	131,77	AR-62	62	291,77	AR-127	127	596,87
AR-36	36	169,42	AR-64	64	301,18	AR-148	148	695,57
AR-39	39	183,53	AR-65	65	305,89	AR-157	157	737,87
AR-43	43	202,36	AR-67	67	315,20	AR-202	202	949,36
AR-45	45	211,77	AR-70	70	329,42	<b>PASO AR - DOBLE DENTADO</b>		
AR-46	46	216,48	AR-73	73	333,54			
AR-53	53	249,42	AR-76	76	357,65	AR-62-DL	62	292,16
AR-54	54	254,12	AR-82	82	385,89	AR-87-DL	87	409,97
AR-56	56	263,54	AR-87	87	409,42			
AR-60	60	282,36	AR-94	94	441,78			

## CORREAS DENTADAS EN POLIURETANO PASO **BR** (7.841/7.854)

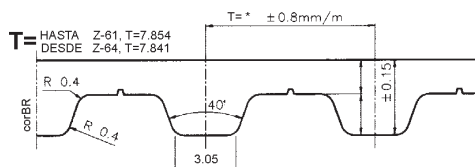
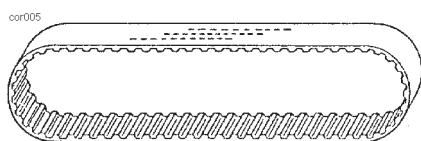

CODIGO	DTES.	MM.	CODIGO	DTES.	MM.	CODIGO	DTES.	MM.
BR-32	32	251,32	BR-67	67	525,35	BR-125	125	980,18
BR-36	36	282,74	BR-70	70	548,90	BR-230-F	230	1803,52
BR-40	40	314,16	BR-75	75	588,10	BR-230-AF	230	1803,52
BR-44	44	345,57	BR-80	80	627,31			
BR-48	48	376,99	BR-86	86	674,36			
BR-50	50	392,70	BR-90	90	705,73			
BR-51	51	400,55	BR-97	97	760,62			
BR-55	55	431,97	BR-100	100	784,10			
BR-61	61	479,69	BR-107	107	839,03			
BR-64	64	501,85	BR-119	119	933,13			



## CORREAS DENTADAS EN POLIURETANO PASO CR (12.553)

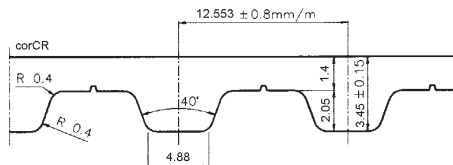
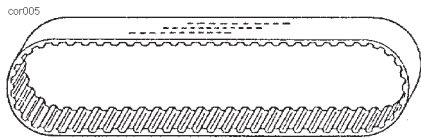

CODIGO	DTES.	MM.	CODIGO	DTES.	MM.	CODIGO	DTES.	MM.																																																					
<table border="1"> <thead> <tr> <th>CODIGO</th> <th>DTES.</th> <th>MM.</th> <th>CODIGO</th> <th>DTES.</th> <th>MM.</th> </tr> </thead> <tbody> <tr> <td>CR-31</td> <td>31</td> <td>389,17</td> <td>CR-76</td> <td>76</td> <td>954,03</td> </tr> <tr> <td>CR-36</td> <td>36</td> <td>451,94</td> <td>CR-78</td> <td>78</td> <td>979,20</td> </tr> <tr> <td>CR-43</td> <td>43</td> <td>539,81</td> <td>CR-80</td> <td>80</td> <td>1004,30</td> </tr> <tr> <td>CR-50</td> <td>50</td> <td>627,69</td> <td>CR-81</td> <td>81</td> <td>1016,86</td> </tr> <tr> <td>CR-53</td> <td>53</td> <td>665,35</td> <td>CR-83</td> <td>83</td> <td>1041,90</td> </tr> <tr> <td>CR-54</td> <td>54</td> <td>677,90</td> <td>CR-85</td> <td>85</td> <td>1067,00</td> </tr> <tr> <td>CR-57</td> <td>57</td> <td>715,57</td> <td>CR-86</td> <td>86</td> <td>1079,56</td> </tr> </tbody> </table>						CODIGO	DTES.	MM.	CODIGO	DTES.	MM.	CR-31	31	389,17	CR-76	76	954,03	CR-36	36	451,94	CR-78	78	979,20	CR-43	43	539,81	CR-80	80	1004,30	CR-50	50	627,69	CR-81	81	1016,86	CR-53	53	665,35	CR-83	83	1041,90	CR-54	54	677,90	CR-85	85	1067,00	CR-57	57	715,57	CR-86	86	1079,56	<b>PASO CR - DOBLE DENTADO</b>							
CODIGO	DTES.	MM.	CODIGO	DTES.	MM.																																																								
CR-31	31	389,17	CR-76	76	954,03																																																								
CR-36	36	451,94	CR-78	78	979,20																																																								
CR-43	43	539,81	CR-80	80	1004,30																																																								
CR-50	50	627,69	CR-81	81	1016,86																																																								
CR-53	53	665,35	CR-83	83	1041,90																																																								
CR-54	54	677,90	CR-85	85	1067,00																																																								
CR-57	57	715,57	CR-86	86	1079,56																																																								
<table border="1"> <thead> <tr> <th>CODIGO</th> <th>DTES.</th> <th>MM.</th> <th>CODIGO</th> <th>DTES.</th> <th>MM.</th> </tr> </thead> <tbody> <tr> <td>CR-59</td> <td>59</td> <td>740,62</td> <td>CR-88</td> <td>88</td> <td>1104,73</td> </tr> <tr> <td>CR-60</td> <td>60</td> <td>753,23</td> <td>CR-94</td> <td>94</td> <td>1180,92</td> </tr> <tr> <td>CR-63</td> <td>63</td> <td>790,89</td> <td>CR-100</td> <td>100</td> <td>1255,38</td> </tr> <tr> <td>CR-66</td> <td>66</td> <td>825,55</td> <td>CR-110</td> <td>110</td> <td>1380,92</td> </tr> <tr> <td>CR-69</td> <td>69</td> <td>866,15</td> <td>CR-115</td> <td>115</td> <td>1443,59</td> </tr> <tr> <td>CR-70</td> <td>70</td> <td>878,77</td> <td>CR-119</td> <td>119</td> <td>1493,90</td> </tr> <tr> <td>CR-75</td> <td>75</td> <td>941,53</td> <td>CR-126</td> <td>126</td> <td>1581,78</td> </tr> <tr> <td></td> <td></td> <td></td> <td>CR-133</td> <td>133</td> <td>1669,65</td> </tr> </tbody> </table>	CODIGO	DTES.	MM.	CODIGO	DTES.	MM.	CR-59	59	740,62	CR-88	88	1104,73	CR-60	60	753,23	CR-94	94	1180,92	CR-63	63	790,89	CR-100	100	1255,38	CR-66	66	825,55	CR-110	110	1380,92	CR-69	69	866,15	CR-115	115	1443,59	CR-70	70	878,77	CR-119	119	1493,90	CR-75	75	941,53	CR-126	126	1581,78				CR-133	133	1669,65	<table border="1"> <tbody> <tr> <td>CR-66-DL</td> <td>66</td> <td>828,55</td> </tr> <tr> <td>CR-88-DL</td> <td>88</td> <td>1104,73</td> </tr> </tbody> </table>	CR-66-DL	66	828,55	CR-88-DL	88	1104,73
CODIGO	DTES.	MM.	CODIGO	DTES.	MM.																																																								
CR-59	59	740,62	CR-88	88	1104,73																																																								
CR-60	60	753,23	CR-94	94	1180,92																																																								
CR-63	63	790,89	CR-100	100	1255,38																																																								
CR-66	66	825,55	CR-110	110	1380,92																																																								
CR-69	69	866,15	CR-115	115	1443,59																																																								
CR-70	70	878,77	CR-119	119	1493,90																																																								
CR-75	75	941,53	CR-126	126	1581,78																																																								
			CR-133	133	1669,65																																																								
CR-66-DL	66	828,55																																																											
CR-88-DL	88	1104,73																																																											

## CORREAS DENTADAS EN POLIURETANO PASO DR (6.271)

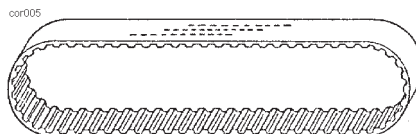
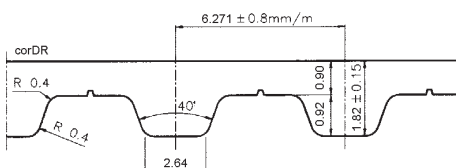

CODIGO	DTES.	MM.	CODIGO	DTES.	MM.	CODIGO	DTES.	MM.
DR-33	33	207,34	DR-83-AF	83	522,46	DR-130	130	815,34
DR-37	37	232,47	DR-88	88	551,81	DR-132	132	827,72
DR-43	43	270,17	DR-90	90	564,36	DR-153	153	959,40
DR-53	53	333,00	DR-98-F	98	614,52	DR-155	155	971,95
DR-55	55	345,57	DR-98-AF	98	614,52	DR-186	186	1166,33
						DR-188	188	1178,88
DR-63	63	395,84	DR-101-F	101	633,33	<b>PASO DR - DOBLE DENTADO</b>		
DR-67	67	420,96	DR-101-AF	101	633,33			
DR-70	70	439,82	DR-104	104	652,14	DR-83-DL	83	520,46
DR-79	79	495,38	DR-117	117	733,66			
DR-83-F	83	520,46	DR-119	119	746,20			

## CORREAS DENTADAS DE NEOPRENO PASO 3 - M

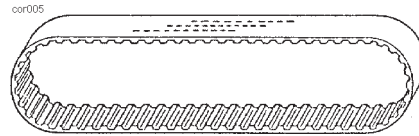
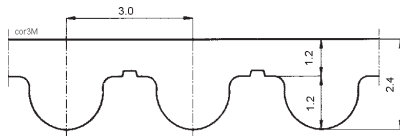

CODIGO	DTES.	MM.	CODIGO	DTES.	MM.	CODIGO	DTES.	MM.
<small>cor037</small>								
105-3M	35	105	333-3M	111	333	690-3M	230	690
108-3M	36	108	336-3M	112	336	696-3M	232	696
111-3M	37	111	339-3M	113	339	711-3M	237	711
120-3M	40	120	345-3M	115	345	735-3M	245	735
123-3M	41	123	357-3M	119	357	738-3M	246	738
129-3M	43	129	360-3M	120	360	750-3M	250	750
141-3M	47	141	363-3M	121	363	753-3M	251	753
144-3M	48	144	369-3M	123	369	783-3M	261	783
147-3M	49	147	381-3M	127	381	795-3M	265	795
150-3M	50	150	384-3M	128	384	804-3M	268	804
156-3M	52	156	390-3M	130	390	843-3M	281	843
159-3M	53	159	396-3M	132	396	858-3M	286	858
165-3M	55	165	399-3M	133	399	861-3M	287	861
168-3M	56	168	405-3M	135	405	873-3M	291	873
174-3M	58	174	411-3M	137	411	882-3M	294	882
177-3M	59	177	420-3M	140	420	936-3M	312	936
180-3M	60	180	423-3M	141	423	945-3M	315	945
186-3M	62	186	432-3M	144	432	981-3M	327	981
189-3M	63	189	435-3M	145	435	1002-3M	334	1002
192-3M	64	192	447-3M	149	447	1050-3M	350	1050
195-3M	65	195	459-3M	153	459	1062-3M	354	1062
201-3M	67	201	462-3M	154	462	1071-3M	357	1071
204-3M	68	204	465-3M	155	465	1125-3M	375	1125
207-3M	69	207	468-3M	156	468	1155-3M	385	1155
210-3M	70	210	474-3M	158	474	1191-3M	397	1191
213-3M	71	213	477-3M	159	477	1245-3M	415	1245
219-3M	73	219	480-3M	160	480	1260-3M	420	1260
225-3M	75	225	483-3M	161	483	1263-3M	421	1263
228-3M	76	228	486-3M	162	486	1500-3M	500	1500
234-3M	78	234	489-3M	163	489	1512-3M	504	1512
237-3M	79	237	501-3M	167	501	1530-3M	510	1530
240-3M	80	240	504-3M	168	504	1800-3M	600	1800
243-3M	81	243	510-3M	170	510	1863-3M	621	1863
246-3M	82	246	513-3M	171	513	1956-3M	652	1956
249-3M	83	249	525-3M	175	525			
252-3M	84	252	531-3M	177	531			
255-3M	85	255	537-3M	179	537			
258-3M	86	258	558-3M	186	558			
264-3M	88	264	564-3M	188	564			
267-3M	89	267	570-3M	190	570			
270-3M	90	270	576-3M	192	576			
276-3M	92	276	582-3M	194	582			
282-3M	94	282	594-3M	198	594			
285-3M	95	285	597-3M	199	597			
288-3M	96	288	600-3M	200	600			
291-3M	97	291	612-3M	204	612			
294-3M	98	294	627-3M	209	627			
297-3M	99	297	633-3M	211	633			
300-3M	100	300	645-3M	215	645			
306-3M	102	306	648-3M	216	648			
309-3M	103	309	663-3M	221	663			
312-3M	104	312	669-3M	223	669			
318-3M	106	318	672-3M	224	672			
327-3M	109	327	681-3M	227	681			
330-3M	110	330	684-3M	228	684			

ANCHURAS STANDARD: 6 mm. - 9 mm. - 15 mm.

# CORREA DENTADA DE NEOPRENO PASO 5 - M

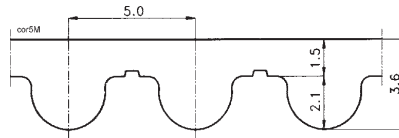
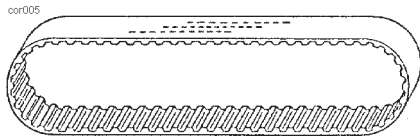

CODIGO	DTES.	MM.	CODIGO	DTES.	MM.
<small>cor038</small>					
120-5M	24	120	700-5M	140	700
125-5M	25	125	710-5M	142	710
175-5M	35	175	740-5M	148	740
180-5M	36	180	750-5M	150	750
200-5M	40	200	755-5M	151	755
225-5M	45	225	770-5M	154	770
230-5M	46	230	775-5M	155	775
245-5M	49	245	800-5M	160	800
255-5M	51	255	810-5M	162	810
265-5M	53	265	825-5M	165	825
270-5M	54	270	830-5M	166	830
280-5M	56	280	835-5M	167	835
295-5M	59	295	845-5M	169	845
300-5M	60	300	850-5M	170	850
305-5M	61	305	860-5M	172	860
320-5M	64	320	870-5M	174	870
325-5M	65	325	890-5M	178	890
330-5M	66	330	900-5M	180	900
335-5M	67	335	920-5M	184	920
340-5M	68	340	925-5M	185	925
345-5M	69	345	930-5M	186	930
350-5M	70	350	935-5M	187	935
360-5M	72	360	940-5M	188	940
365-5M	73	365	950-5M	190	950
370-5M	74	370	965-5M	193	965
375-5M	75	375	975-5M	195	975
385-5M	77	385	980-5M	196	980
400-5M	80	400	1000-5M	200	1000
405-5M	81	405	1025-5M	205	1025
410-5M	82	410	1035-5M	207	1035
420-5M	84	420	1050-5M	210	1050
425-5M	85	425	1100-5M	220	1100
450-5M	90	450	1125-5M	225	1125
460-5M	92	460	1135-5M	227	1135
475-5M	95	475	1145-5M	229	1145
480-5M	96	480	1200-5M	240	1200
495-5M	99	495	1225-5M	245	1225
500-5M	100	500	1235-5M	247	1235
520-5M	104	520	1250-5M	250	1250
525-5M	105	525	1270-5M	254	1270
535-5M	107	535	1295-5M	259	1295
550-5M	110	550	1350-5M	270	1350
560-5M	112	560	1380-5M	276	1380
565-5M	113	565	1420-5M	284	1420
575-5M	115	575	1575-5M	315	1575
580-5M	116	580	1595-5M	319	1595
585-5M	117	585	1690-5M	338	1690
600-5M	120	600	1790-5M	358	1790
610-5M	122	610	1800-5M	360	1800
615-5M	123	615	1870-5M	374	1870
625-5M	125	625	1895-5M	379	1895
635-5M	127	635	1945-5M	389	1945
640-5M	128	640	2000-5M	400	2000
645-5M	129	645	2250-5M	450	2250
665-5M	133	665	2350-5M	470	2350
670-5M	134	670	2525-5M	505	2525
695-5M	139	695			

ANCHURAS STANDARD: 9 mm. - 15 mm. - 25 mm.

## CORREA DENTADA DE NEOPRENO PASO 8 - M

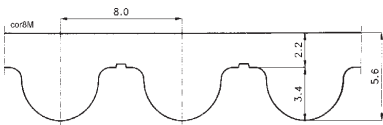

CODIGO	DTES.	MM.	CODIGO	DTES.	MM.
<small>cor03e</small>					
376-8M	47	376	1200-8M	150	1200
424-8M	53	424	1280-8M	160	1280
480-8M	60	480	1440-8M	180	1440
560-8M	70	560	1600-8M	200	1600
600-8M	75	600	1760-8M	220	1760
640-8M	80	640			
720-8M	90	720			
800-8M	100	800	1800-8M	225	1800
880-8M	110	880	2000-8M	250	2000
960-8M	120	960	2400-8M	300	2400
1040-8M	130	1040	2600-8M	325	2600
1120-8M	140	1120	2800-8M	350	2800

ANCHURAS STANDARD: 20 mm. - 30 mm. - 50 mm. - 85 mm.

## CORREA DENTADA DE NEOPRENO PASO 14 - M

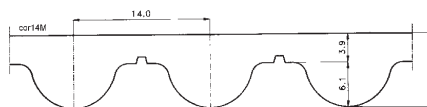

CODIGO	DTES.	MM.	CODIGO	DTES.	MM.
<small>cor04u</small>					
966-14M	69	966	2450-14M	175	2450
1190-14M	85	1190	2590-14M	185	2590
1400-14M	100	1400	2800-14M	200	2800
1610-14M	115	1610	3150-14M	225	3150
1778-14M	127	1778	3500-14M	250	3500
1890-14M	135	1890	3850-14M	275	3850
2100-14M	150	2100	4326-14M	309	4326
2310-14M	165	2310	4578-14M	327	4578

ANCHURAS STANDARD: 40 mm. - 55 mm. - 85 mm. - 115 mm. - 170 mm.

## CORREA DENTADA DE NEOPRENO PASO 20 - M

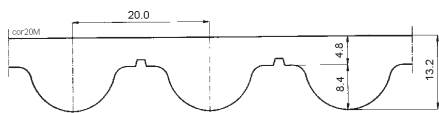

CODIGO	DTES.	MM.	CODIGO	DTES.	MM.
<small>cor041</small>					
2000-20M	100	2000	5400-20M	270	5400
2500-20M	125	2500	5800-20M	290	5800
3400-20M	170	3400	6200-20M	310	6200
4200-20M	210	4200	6600-20M	330	6600
5000-20M	250	5000			

## CORREA DENTADA A METROS

### PASO T5 mm. - AT5 mm.

Anchos suministrables: hasta 75 mm.  
Material: POLIURETANO

### PASO T10 mm. - AT10 mm.

Anchos suministrables: hasta 100 mm.  
Material: POLIURETANO

### PASO T20 mm. - AT20 mm.

Anchos suministrables: hasta 150 mm.  
Material: POLIURETANO

### PASO 8M

Anchos suministrables: hasta 80 mm.  
Material: NEOPRENO

### PASO XL (5.08 mm. - 1/5")

Anchos suministrables: 025 ( 6.35 mm.) - 031 ( 7.94 mm.) - 037 (9.53 mm.)  
050 (12.7 mm.) - 075 (19.05 mm.) - 100 (25.4 mm.)  
Material: NEOPRENO Y POLIURETANO

### PASO L ( 9.52 mm. - 3/8")

Anchos suministrables: 037 ( 9.53 mm.) - 050 (12.70 mm.) - 075 (19.05 mm.)  
100 (25.4 mm.) - 075 (19.05 mm.) - 100 (25.4 mm.)  
Material: NEOPRENO Y POLIURETANO

### PASO H (12.70 mm. - 1/2")

Anchos suministrables: 050 ( 12.7 mm.) - 075 (19.05 mm.) - 100 (25.4 mm.)  
150 ( 38,1 mm.) - 200 (50.8 mm.) 300 (76.2 mm.)  
400 (101.6 mm.)  
Material: NEOPRENO Y POLIURETANO

### PASO XH (22.225 mm. - 7/8")

Anchos suministrables: 100 (25.4 mm.) - 150 (38,1 mm.) - 200 (50.8 mm.)  
300 (76.2 mm.) - 400 (101.6 mm.)  
Material: NEOPRENO

CALIDADES: PAR con tejido recubrimiento en el lomo, PAZ, en el diente, PAR-PAZ, en ambos y AUSF. T. de poliuretano en el lomo.



# CORREAS POLY-V

Poly-V es una correa sin-fin ranurada en sentido longitudinal con dientes de perfil triangular.

El armazón esta compuesto de una sola capa de cables de alta resistencia, enrollados en continuo en toda su anchura.

La incompresibilidad del caucho asegura una repartición homogénea de la presión sobre toda la superficie de contacto polea-correa. Esta es TRES VECES mayor en una correa Poly-V que en una

correa plana de la misma anchura.

Contrariamente a las correas trapeziales, cuya adherencia polea-correa se obtiene por acuñaamiento de los flancos de las correas en las gargantas de las poleas, en POLY-V es obtenida por el contacto de toda la superficie de la correa sobre la polea.

Cualquiera que sea la potencia a transmitir POLY-V es siempre mono-correa.

La gran superficie de contacto de POLY-V debida a sus múltiples dientes, reduce la presión unitaria, el desgaste y aumenta su

duración.

POLY-V es la solución ideal para una variedad de problemas generales de transmisión, ya que su poco espesor permite su utilización en instalaciones con diámetros de poleas desde 20 mm., relaciones de velocidad muy elevadas y velocidades tangenciales constantes de hasta 50 m/s.

POLY-V ofrece buena resistencia a los aceites, grasas y temperaturas.

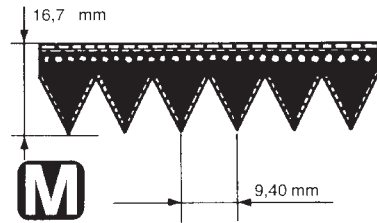
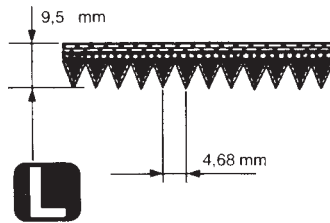
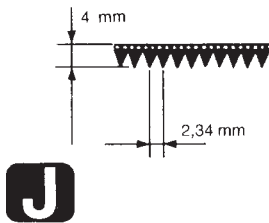
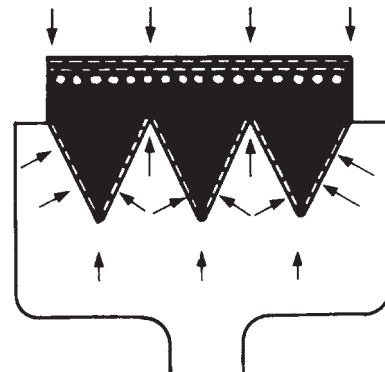

Longitudes primitivas				Longitudes primitivas				Longitudes primitivas							
Pulgadas		mm		Pulgadas		mm		Pulgadas		mm		Pulgadas		mm	
cor003	8.0	203	36.0	914	37.5	954	88.0	2235	90.0	2286	183.0	4648			
	8,5	216	37,6	955	39,0	991	91,5	2324	94,0	2388	198,0	5029			
	9,0	229	38,0	965	42,3	1075	93,0	2362	99,0	2515	213,0	5410			
	9,5	241	40,0	1016	47,0	1195	97,5	2476	106,0	2693	241,0	6121			
	10,0	254	43,0	1092	50,0	1270	99,0	2515	111,5	2832	271,0	6883			
	10,5	267	44,5	1130	52,5	1333	106,5	2706	115,0	2921	301,0	7646			
	11,0	279	46,0	1168	54,0	1371	108,0	2743	118,5	3010	331,0	8408			
	12,0	305	47,2	1200	55,0	1397	112,0	2845	123,0	3124	361,0	9169			
	13,0	330	49,0	1244	56,0	1422	114,0	2895	131,0	3327	391,0	9931			
	14,0	356	50,0	1270	58,2	1480	115,0	2921	139,0	3531	421,0	10693			
	15,0	381	50,4	1280	61,5	1562	118,0	2997	147,0	3734	481,0	12217			
	16,0	406	52,0	1321	63,5	1613	121,5	3086	161,0	4089	541,0	13741			
	17,0	432	53,3	1355	65,5	1664	123,0	3124	165,0	4191	601,0	15266			
	18,0	457	55,0	1397	67,5	1715	129,5	3289	176,0	4470					
	19,0	483	56,2	1428	69,5	1764	131,0	3327							
	20,0	508	58,0	1473	71,0	1803	137,5	3492							
	22,0	559	61,0	1549	72,5	1841	145,5	3696							
	24,0	610	63,0	1600	76,5	1943	159,5	4051							
	26,0	660	65,0	1651	78,0	1981	165,0	4191							
	28,0	711	65,5	1663	79,5	2020	176,0	4470							
	28,4	723	69,0	1752	81,5	2070	182,0	4622							
	30,0	762	73,0	1854	82,5	2096	198,0	5029							
	32,0	813	75,2	1910	84,0	2134	212,0	5385							
	34,0	864	77,0	1956	86,5	2197	240,0	6096							
			77,4	1965											
			78,4	1992											
			82,0	2083											
			87,0	2210											
			92,0	2337											
			98,0	2489											