

# NEUMÁTICA

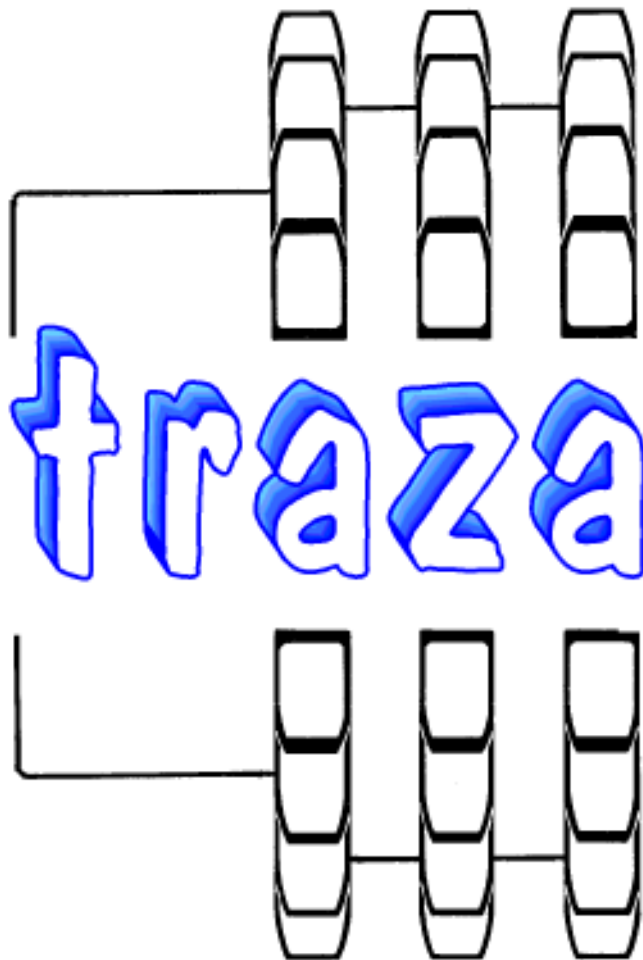

Transmisiones Zaragoza, S.L.

Isla de Menorca, s/nr. - Edificio Estrella, Local nr. 2

50014 - Zaragoza

Tfno. (976) 47 01 02 (8 líneas) - Fax (976) 47 32 20

E-Mail: [traza@trazasl.com](mailto:traza@trazasl.com)

[www.trazasl.com](http://www.trazasl.com)

# Transmisiones Zaragoza, S.L.

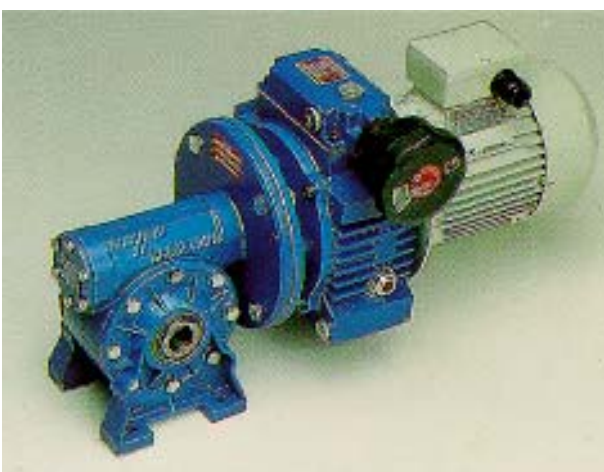
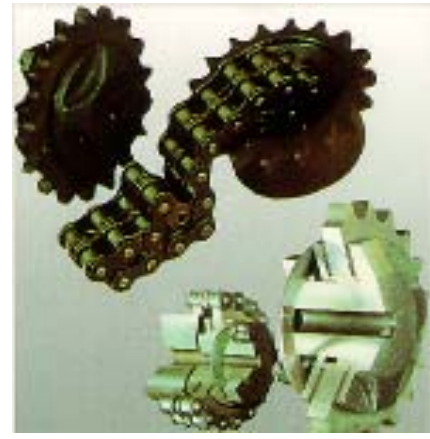

# Indice

## **N**

NEUMATICA  
NEUMATICA  
Neumática, 5



# CILINDROS NEUMATICOS

neumat03

**Serie 132 y 133.**  
Pistón magnético

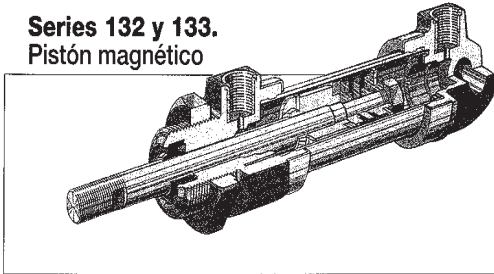

Carreras standard mm.

Diam. Cilindro	12	25	50	80	100	125	160	200	250	320	400	500
8	⊗	⊗	⊗	⊗								
10	⊗	⊗	⊗	⊗								
12	⊗	⊗	⊗	⊗	⊗							
16	⊗	⊗	⊗	⊗	⊗	⊗						
20	⊗	⊗	⊗	⊗	⊗	⊗	⊗					
25	⊗	⊗	⊗	⊗	⊗	⊗	⊗	⊗				
32		⊗	⊗	⊗	⊗	⊗	⊗	⊗	⊗			

neumat05

**Fijaciones para cilindro Series 132 - 133**

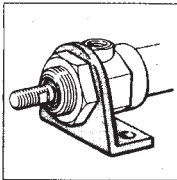

Tipo 22

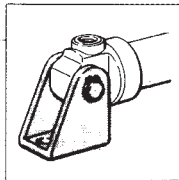

Tipo 34

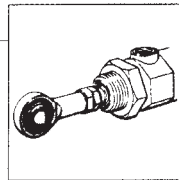

Tipo 9

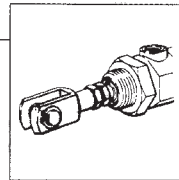

Tipo 5

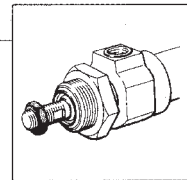

Tipo 2

neumat05

**Serie 170.**  
Cilindro sin vástago.  
Sin lubricación.  
Pistón magnético.

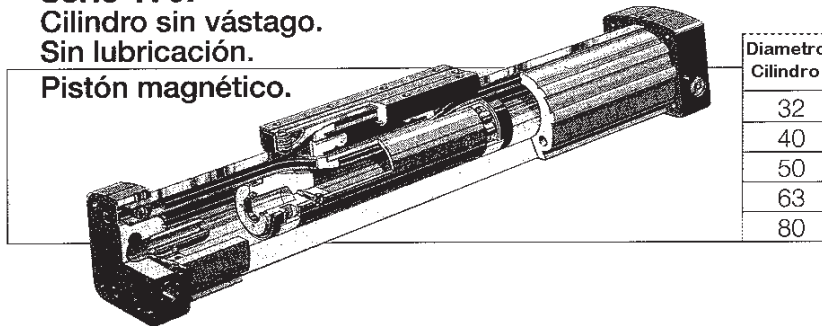

Diametro Cilindro
32
40
50
63
80

**Fijaciones para cilindro Serie 170**

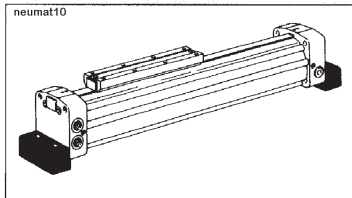

Tipo 40

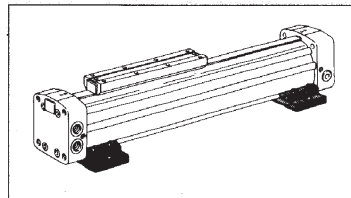

Tipo 41

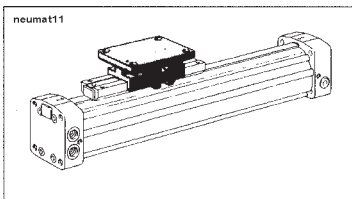

Tipo 44

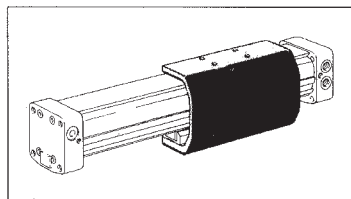

Tipo 43

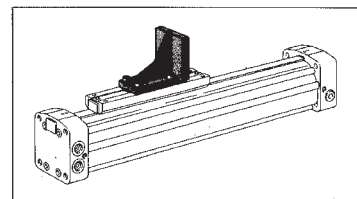

Tipo 42

## CILINDROS NEUMATICOS

**Serie 167.**  
Norma ISO. Sin lubricación.  
Pistón magnético.

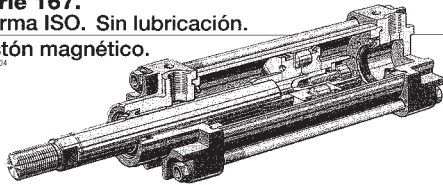

**Serie 167-58.**  
Cilindro con vástago antigiro.  
Norma ISO. Sin lubricación.  
Pistón magnético.

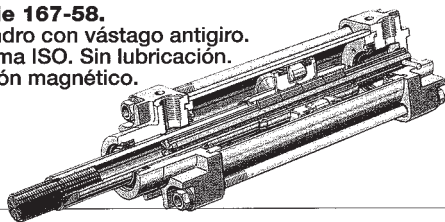

Diametro Cilindros	Carreras Standard mm.									
25										
32										
40										
50										
63										
80										
100										
125										
160										
200										
250										
320										
32										
40										
50										
63										

### Fijaciones para cilindro Serie 167

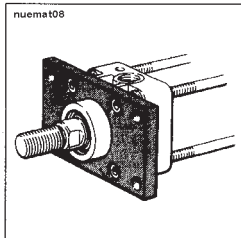

Tipo 20

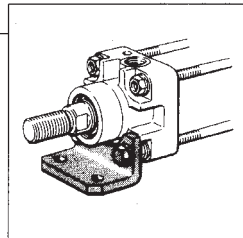

Tipo 22

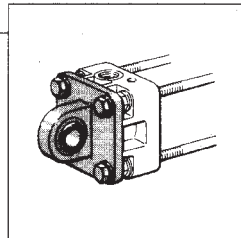

Tipo 36

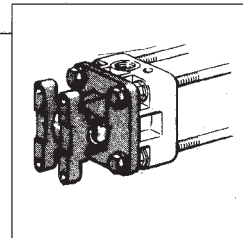

Tipo 35

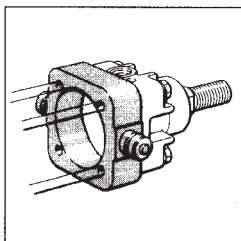

Tipo 28

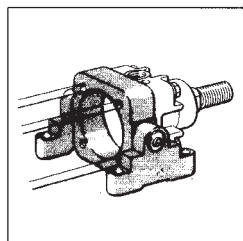

Tipo 26

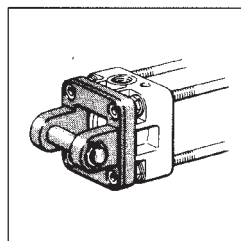

Tipo 29

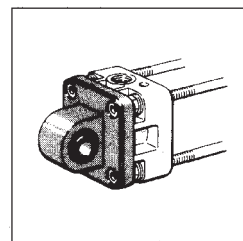

Tipo 32

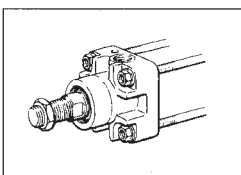

Tipo 3

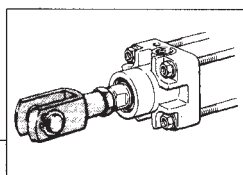

Tipo 5

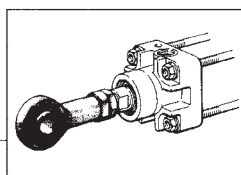

Tipo 9

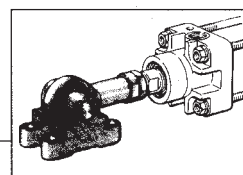

Tipo 10

# VALVULAS MANUALES Y ELECTROVALVULAS

## Válvulas Compact. Serie 585.

Válvulas de 5 vías con mando neumático o mando eléctrico.

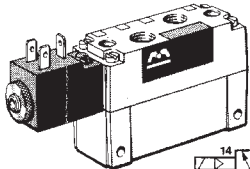

Ref.  
585 - 111 - 000 1/8  
585 - 211 - 000 1/4

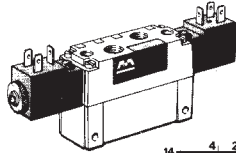

Ref.  
585 - 122 - 000 1/8  
585 - 222 - 000 1/4

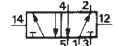
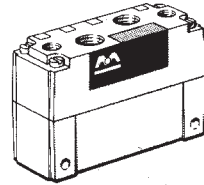

Ref.  
585 - 113 - 000 1/8  
585 - 213 - 000 1/4

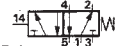

Ref.  
585 - 123 - 000 1/8  
585 - 223 - 000 1/4

## Válvulas norma ISO. Serie 581.

Válvulas de 5 vías. Montaje sobre placa base. Mando neumático o mando eléctrico.

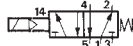
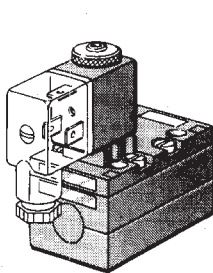

Ref.  
ISO 1. 581- 111- 000  
ISO 2. 581- 211- 000  
ISO 3. 581- 311- 000  
ISO 4. 581- 411- 000

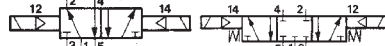
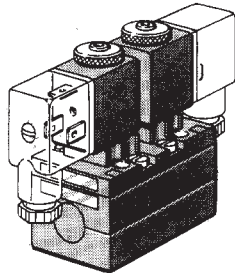

Ref.  
581- 122- 000  
581- 222- 000  
581- 322- 000  
581- 422- 000

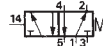
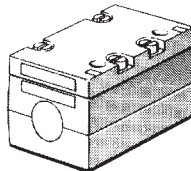

Ref.  
ISO 1. 581- 113- 000  
ISO 2. 581- 213- 000  
ISO 3. 581- 313- 000  
ISO 4. 581- 413- 000

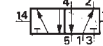

ISO 1. 581- 123- 000  
ISO 2. 581- 223- 000  
ISO 3. 581- 323- 000  
ISO 3. 581- 423- 000

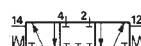

ISO 1. 581- 143- 000  
ISO 2. 581- 243- 000  
ISO 3. 581- 343- 000  
ISO 4. 581- 443- 000

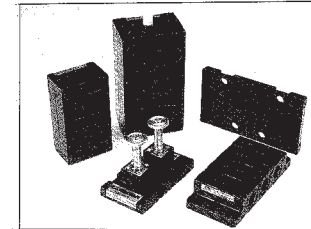

Placa Base

Ref.  
580- 171- 000 ISO 1 G 1/8  
580- 174- 000 ISO 1 G 1/4  
580- 271- 000 ISO 2 G 1/4  
580- 274- 000 ISO 2 G 3/8  
580- 371- 000 ISO 3 G 3/8  
580- 471- 000 ISO 4 G 1/2  
580- 444- 000 ISO 4 G 3/4

## Válvulas de 3 vías. Serie 560.

Mando neumático o mando eléctrico. Gran capacidad de caudal. Variantes para alta temperatura y para alta presión.

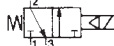
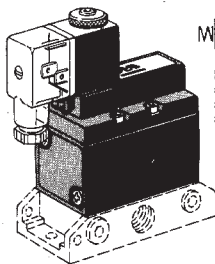

Ref.  
563 - 301  
565 - 301  
567 - 301

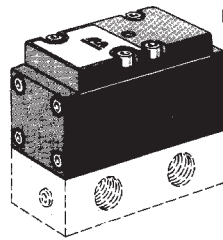

Ref.  
563 - 201  
565 - 201  
567 - 201

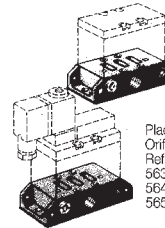

Placa Base

Orificios laterales

Ref.  
563 - 442 Dim. G1/4 565 - 442 Dim. G3/4  
564 - 442 Dim. G3/4 567 - 442 Dim. G1  
565 - 442 Dim. G1/2

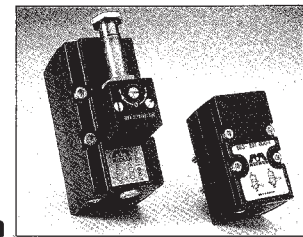

## Válvulas de mando. Serie 550.

Válvulas de 3 vías con diferentes tipos de accionamiento. Rosca de conexión R1/8"

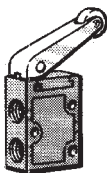

Ref.  
550 - 0280 - 000

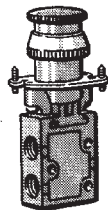

Ref.  
550 - 053 - 000

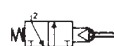

Ref.  
550 - 009 - 000

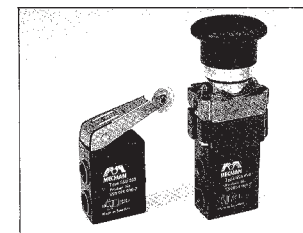

## ACCESORIOS PARA AIRE COMPRIMIDO

neumat02

### Filtros Reguladores Lubrificadores

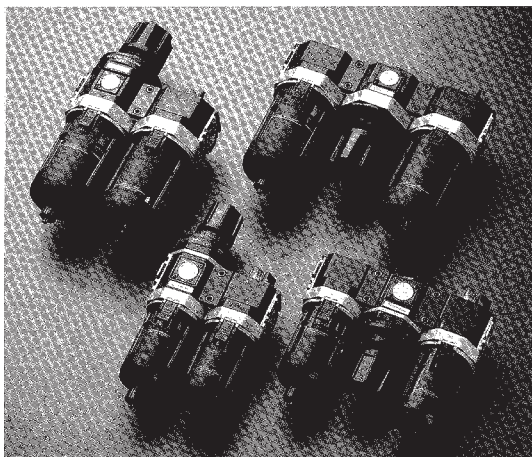

1/4" F. 3000.8 R. 3000.8 L. 3000.8  
3/8" F. 3000.10 R. 3000.10 L. 3000.10  
1/2" F. 4000.15 R. 3000.15 L. 4000.15

### Accesorios



Amplia gama de racores de conexión instantánea para tubo hasta  $\varnothing$  14 y de tuerca y anillo para tubo hasta  $\varnothing$  25. Tubería de poliamida y cobre

## Amortiguadores de choque

### Amortiguador. Serie 370.

Disponibles en diámetro 12, 20 y 32 mm.  
con dos carreras dentro de cada diámetro.  
Deceleración lineal sin rebotes. Tope mecánico,  
recorrido total sin deterioros. Indicación de nivel  
de aceite mecánico, que puede utilizarse para  
accionamiento de fines de carrera.

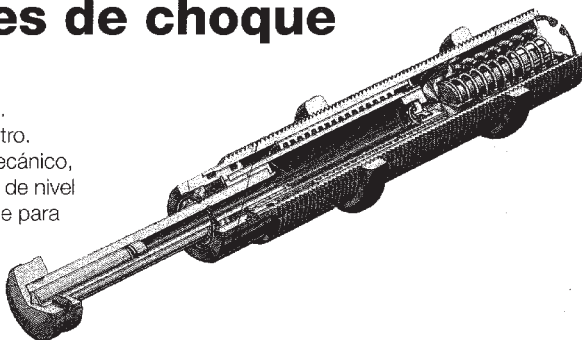

## Armarios de control y sistemas de automatización

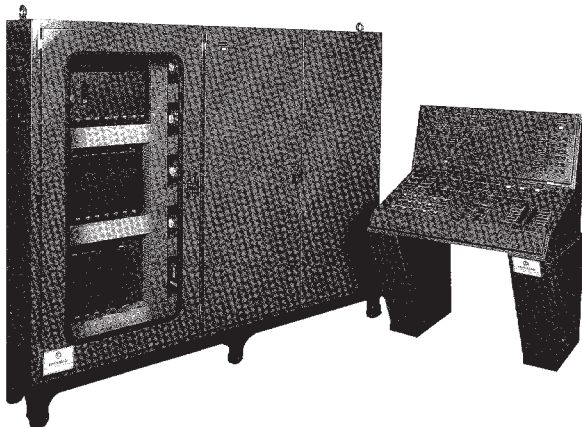

Estudio y montaje de cuadros de mando,  
según necesidades del cliente.

El equipo técnico dedicado a esta labor,  
une sus conocimientos y su experiencia  
ofreciendo:

- Responsabilidad.
- Fiabilidad y garantía.

Podemos realizar el estudio del ciclo de  
control, secuencial, etc. que usted debe  
realizar, o bien remitirnos su esquema  
(en cualquier simbología) y le remitiremos  
nuestro presupuesto.

Si desea recibir más información sobre nuestros productos, tenemos a su disposición nuestro catálogo general.